

Wide range 400W L6599-based HB LLC resonant converter for PDP application

Introduction

This note describes the performances of a 400 W reference board, with wide-range mains operation and power-factor-correction (PFC) and presents the results of its bench evaluation. The electrical specification refers to a power supply for a typical high-end PDP application.

The main features of this design are the very low no-load input consumption (<0.5 W) and the very high global efficiency, better than 90% at full load and nominal mains voltage (115 - 230 V_{AC}).

The circuit consists of three main blocks. The first is a front-end PFC pre-regulator based on the L6563 PFC controller. The second stage is a multi-resonant half-bridge converter with an output voltage of +200 V/400 W, whose control is implemented through the L6599 resonant controller. A further auxiliary flyback converter based on the VIPer12A off-line primary switcher completes the architecture. This third block, delivering a total power of 7 W on two output voltages (+3.3 V and +5 V), is mainly intended for microprocessor supply and display power management operations.

L6599 & L6563 400W demo board (EVAL6599-400W-S)

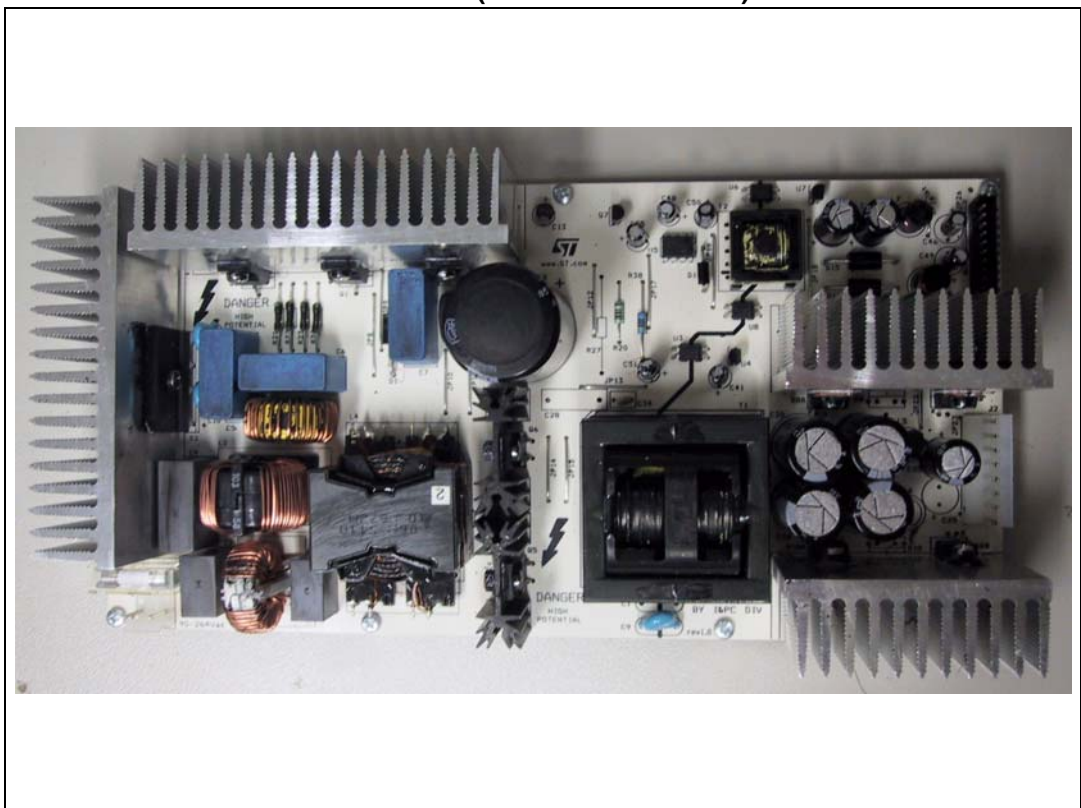

Contents

- 1 Main characteristics and circuit description 4**
- 2 Electrical test results 9**
 - 2.1 Harmonic content measurement 9
 - 2.2 Efficiency measurements 10
 - 2.3 Resonant stage operating waveforms 12
 - 2.4 Stand-by and no-load power consumption 15
 - 2.5 Short-circuit protection 16
 - 2.6 Overvoltage protection 17
- 3 Thermal tests 18**
- 4 Conducted emission pre-compliance test 20**
- 5 Bill of materials 22**
- 6 PFC coil specification 28**
 - 6.1 Electrical characteristics 28
 - 6.2 Mechanical aspect and pin numbering 28
- 7 Resonant power transformer specification 29**
 - 7.1 Electrical characteristics 29
- 8 Auxiliary flyback power transformer 31**
 - 8.1 Electrical characteristics 31
- 9 Board layout 32**
- 10 References 34**
- 11 Revision history 34**

List of figures

Figure 1.	PFC pre-regulator electrical diagram	6
Figure 2.	Resonant converter electrical diagram	7
Figure 3.	Auxiliary converter electrical diagram	8
Figure 4.	Compliance to EN61000-3-2 for harmonic reduction: full load	9
Figure 5.	Compliance to EN EN61000-3-2 for harmonic reduction: 70 W load	9
Figure 6.	Compliance to JEIDA-MITI standard for harmonic reduction: full load	9
Figure 7.	Compliance to JEIDA-MITI standard for harmonic reduction: 70 W load	9
Figure 8.	Power factor vs. Vin & load.	10
Figure 9.	Total harmonic distortion vs. Vin & load	10
Figure 10.	Overall efficiency versus output power at nominal mains voltages.	10
Figure 11.	Overall efficiency versus input mains voltage at various output power levels	12
Figure 12.	Resonant circuit primary side waveforms at full load	13
Figure 13.	Resonant circuit primary side waveforms at light load (about 30 W output power)	13
Figure 14.	Resonant circuit primary side waveforms at no load condition	14
Figure 15.	Resonant circuit secondary side waveforms: +200 V output	14
Figure 16.	Low frequency (100 Hz) ripple voltage on the +200 V output.	15
Figure 17.	Load transition (0.4 A - 2 A) on +200 V output voltage.	15
Figure 18.	+200 V output short-circuit waveforms	17
Figure 19.	Thermal map @115 V _{AC} - full load	19
Figure 20.	Thermal map at 230 V _{AC} - full load	19
Figure 21.	Peak measurement on LINE at 115 V _{AC} and full load	20
Figure 22.	Peak measurement on NEUTRAL at 115 V _{AC} and full load	20
Figure 23.	Peak measurement on LINE at 230 V _{AC} and full load	21
Figure 24.	Peak measurement on NEUTRAL at 230 V _{AC} and full load	21
Figure 25.	Electrical diagram	28
Figure 26.	Pin side view	29
Figure 27.	Electrical diagram	29
Figure 28.	Mechanical aspect and pin numbering	30
Figure 29.	Winding position on coil former.	30
Figure 30.	Electrical diagram	31
Figure 31.	Auxiliary transformer winding position on coil former	32
Figure 32.	Copper tracks	32
Figure 33.	Thru-hole component placing and top silk screen	33
Figure 34.	SMT component placing and bottom silk screen	33

1 Main characteristics and circuit description

The main characteristics of the SMPS are listed below:

- Universal input mains range: 90 to 264 V_{AC} - 45 to 65 Hz
- Output voltages: 200 V @ 2 A - 3.3 V @ 0.7 A - 5 V @ 1 A
- Mains harmonics: Compliance with EN61000-3-2 specifications
- Stand-by mains consumption: Typical 0.5 W @230 V_{AC}
- Overall efficiency: better than 88% at full load, 90-264 V_{AC}
- EMI: Compliance with EN55022-class B specifications
- Safety: Compliance with EN60950 specifications
- PCB single layer: 132x265 mm, mixed PTH/SMT technologies

The circuit consists of three stages. A front-end PFC pre-regulator implemented by the controller L6563 ([Figure 1](#)), a half-bridge resonant DC/DC converter based on the resonant controller L6599 ([Figure 2](#)) and a 7 W flyback converter intended for stand-by management ([Figure 3](#)) utilizing the VIPer12A off-line primary switcher.

The PFC stage delivers a stable 400 VDC supply to the downstream converters (resonant + flyback) and provides for the reduction of the current harmonics drawn from the mains, in order to meet the requirements of the European norm EN61000-3-2 and the JEIDA-MITI norm for Japan.

The PFC controller is the L6563 (U1), integrating all functions needed to operate the PFC and interface the downstream resonant converter. Though this controller chip is designed for Transition-Mode (TM) operation, where the boost inductor works next to the boundary between Continuous (CCM) and Discontinuous Conduction Mode (DCM), by adding a simple external circuit, it can be operated in LM-FOT (line-modulated fixed off-time) mode, allowing Continuous Conduction Mode operation, normally achievable with more expensive control chips and more complex architectures. This operative mode allows the use of this device at a high power level, usually covered by CCM topologies. For a detailed and complete description of the LM-FOT operating mode, see the application note AN1792. The external components to configure the circuit in LM-FOT mode are: C15, C17, D5, Q3, R14, R17 and R29.

The power stage of the PFC is a conventional boost converter, connected to the output of the rectifier bridge through a differential mode filtering cell (C5, C6 and L3) for EMI reduction. It includes a coil (L4), a diode (D3), and two capacitors (C7 and C8). The boost switch consists of two Power MOSFETs (Q1 and Q2), connected in parallel, which are directly driven by the L6563 output drive thanks to the high current capability of the IC. The divider (R30, R31 and R32) connected to MULT pin 3 brings the information of the instantaneous voltage that is used to modulate the boost current and to derive further information like the average value of the AC line used by the VFF (voltage feed-forward) function. This function is used to keep the output voltage almost independent of the mains.

The divider (R3, R6, R8, R10 and R11) is dedicated to detecting the output voltage while a further divider (R5, R7, R9, R16 and R25) is used to protect the circuit in case of voltage loop failure.

The second stage is an LLC resonant converter, with half-bridge topology implementation, working in ZVS (zero voltage switching) mode. The controller is the L6599 integrated circuit that incorporates the necessary functions to properly drive the two half-bridge MOSFETs by a 50% fixed duty cycle with fixed dead-time, changing the frequency according to the

feedback signal in order to regulate the output voltages against load and input voltage variations.

The main features of the L6599 are a non-linear soft-start, a current protection mode used to program the hiccup mode timing, a dedicated pin for sequencing or brown-out (LINE) and a stand-by pin (STBY) for burst mode operation at light loads (not used in this design).

The transformer (T1) uses the magnetic integration approach, incorporating the resonant series and shunt inductances of the LLC resonant tank. Thus, no additional external coils are needed for the resonance. For a detailed analysis of the LLC resonant converter, please refer to the application note AN2450.

The secondary side power circuit is configured with a single-ended transformer winding and full-bridge rectification (diodes D8A, D8B, D10A, D10B), which is more suitable for the current design. In fact, with this configuration, the total junction capacitance of the output diodes reflected at primary side is one half the capacitance in case of center-tap transformer. This capacitance at transformer primary side may affect the behavior of the resonant tank, changing the circuit from LLC to LLCC type, with the risk that the converter, in light-load/no-load condition (when the feedback loop increases the operating frequency) can no longer control the output voltage. If the converter has to operate down to zero load, this capacitance needs to be minimized. An inherent advantage of the full-bridge rectification is that the voltage rating of the output diodes in this configuration is one half the rating necessary for center-tap and two diodes circuit, which translates into a lower junction capacitance device, with consequent lower reflected capacitance at primary side.

The feedback loop is implemented by means of a classical configuration using a TL431 (U4) to adjust the current in the optocoupler diode (U3). The optocoupler transistor modulates the current from controller Pin 4, so the frequency will change accordingly, thus achieving the output voltage regulation. Resistors R46 and R54 set the maximum operating frequency. In case of a short circuit, the current entering the primary winding is detected by the lossless circuit (C34, C39, D11, D12, R43, and R45) and the resulting signal is fed into L6599 Pin 6.

In case of overload, the voltage on Pin 6 will exceed an internal threshold that triggers a protection sequence via Pin 2, keeping the current flowing in the circuit at a safe level.

The third stage is a small flyback converter based on the VIPer12A, a current mode controller with integrated Power MOSFET, capable of delivering about 7 W total output power on the output voltages (5 V and 3.3 V). The regulated output voltage is the 3.3 V output and, also in this case, the feedback loop uses the TL431 (U7) and optocoupler (U6) to control the output voltage. This converter is able to operate in the whole mains voltage range, even when the PFC stage is not working. From the auxiliary winding on the primary side of the flyback transformer (T2), a voltage V_s is available, intended to supply the other controllers (L6563 and L6599) in addition to the VIPer12A itself.

The PFC stage and the resonant converter can be switched on and off through the circuit based mainly on components Q7, Q8, D22 and U8, which, depending on the level of the signal ST-BY, supplies or removes the auxiliary voltage (VAUX) necessary to start up the controllers of the PFC and resonant stages. When the AC input voltage is applied to the power supply, the small flyback converter switches on first. Then, when the ST-BY signal is low, the PFC pre-regulator becomes operative, and the resonant converter can deliver the output power to the load. Note that if Pin 9 of Connector J3 is left floating (no signal ST-BY present), the PFC and resonant converter will not operate, and only +5 V and +3.3 V supplies are available on the output. In order to enable the +200 V output, Pin 9 of Connector J3 must be pulled down to ground.

Figure 1. PFC pre-regulator electrical diagram

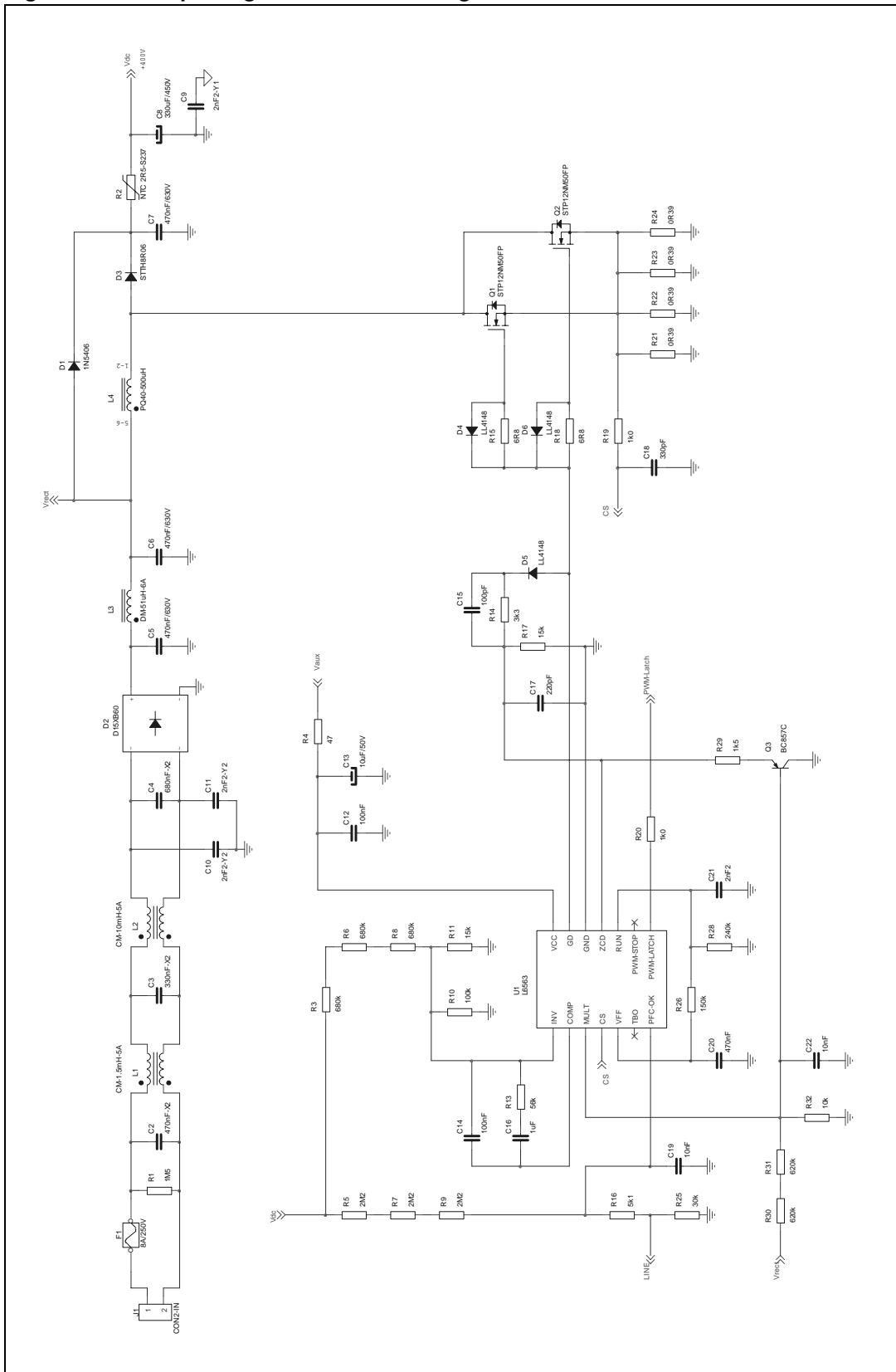

Figure 2. Resonant converter electrical diagram

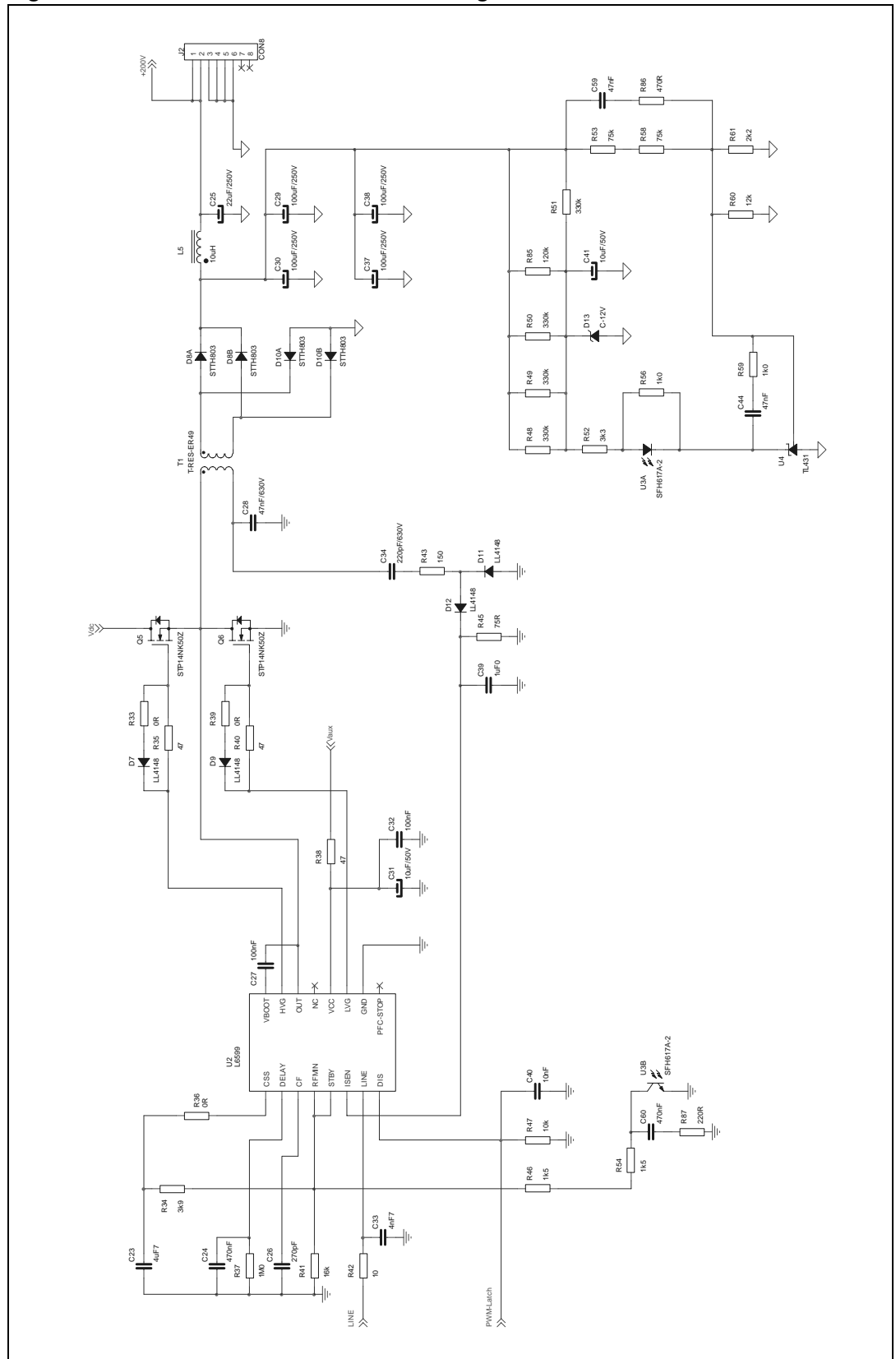
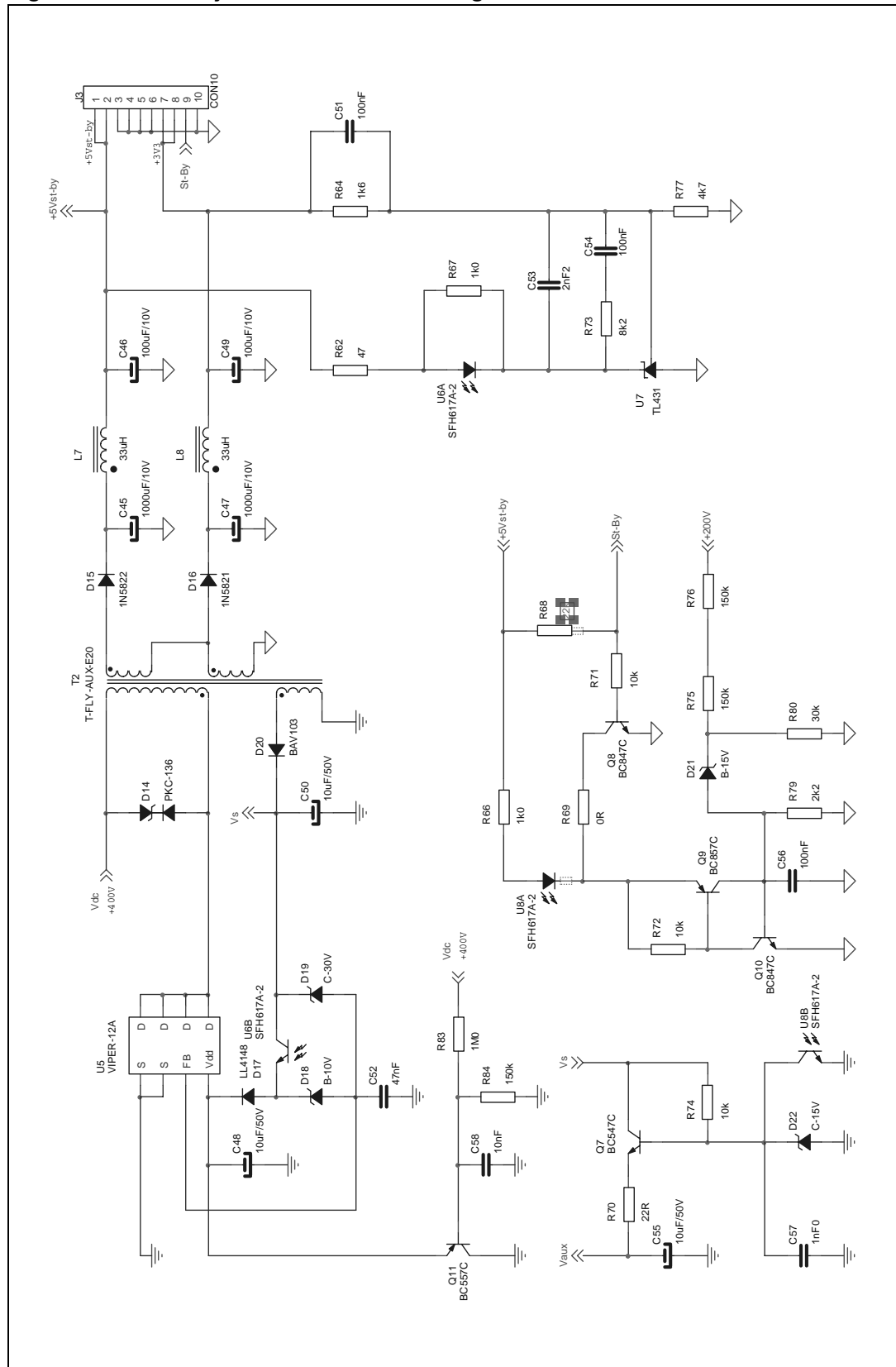

Figure 3. Auxiliary converter electrical diagram



2 Electrical test results

2.1 Harmonic content measurement

The current harmonics drawn from the mains have been measured according to the European rule EN61000-3-2 Class-D and Japanese rule JEIDA-MITI Class-D, at full load and 70 W output power, at both nominal input voltages (230 V_{AC} and 100 V_{AC}). The pictures in [Figure 4.](#), [Figure 5.](#), [Figure 6.](#) and [Figure 7.](#) show that the measured current harmonics are well below the limits imposed by the regulations, both at full load and at 70 W load.

Figure 4. Compliance to EN61000-3-2 for harmonic reduction: full load

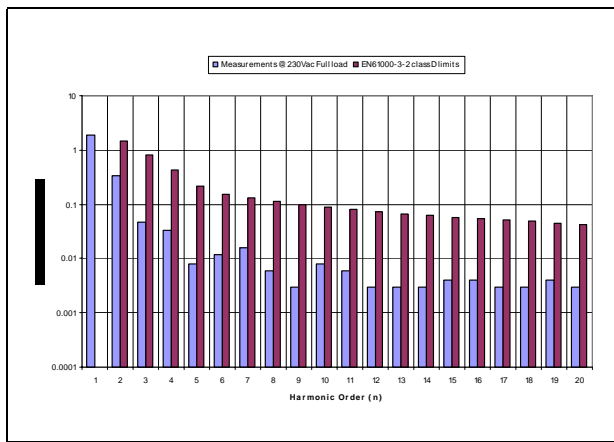

Figure 5. Compliance to EN EN61000-3-2 for harmonic reduction: 70 W load

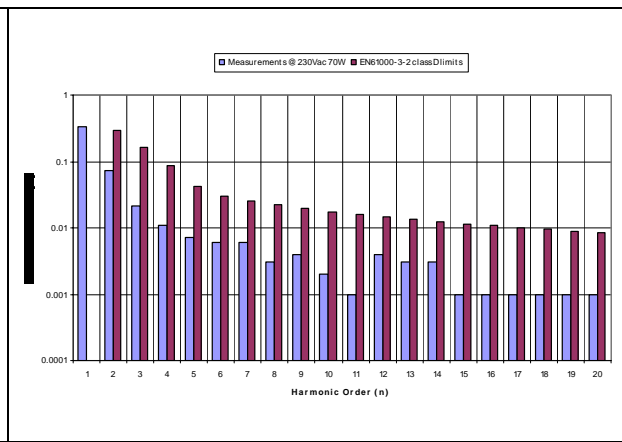

Figure 6. Compliance to JEIDA-MITI standard for harmonic reduction: full load

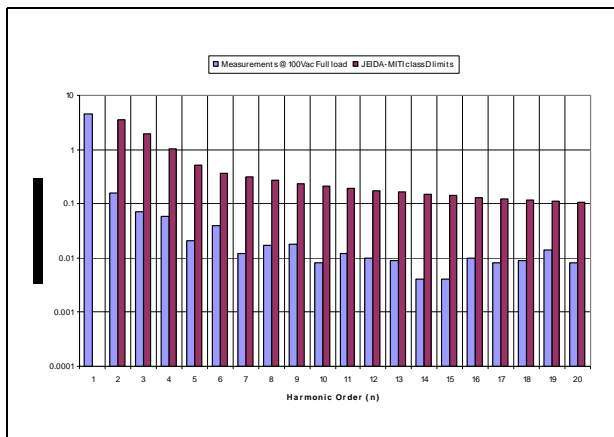
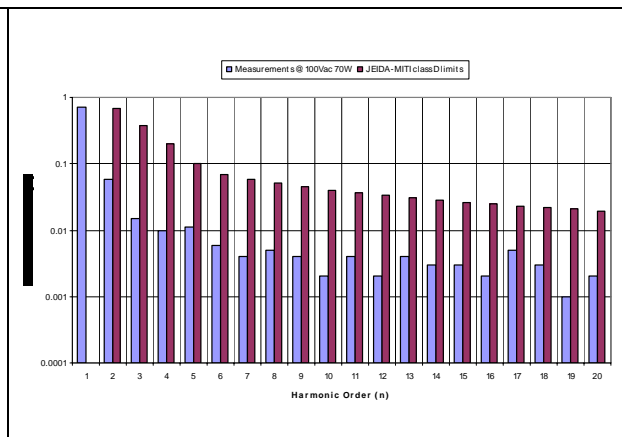

Figure 7. Compliance to JEIDA-MITI standard for harmonic reduction: 70 W load



The Power Factor (PF) and the Total Harmonic Distortion (THD) are reported in [Figure 8.](#) and [Figure 9.](#) It is evident from the picture that the PF stays close to unity in the whole mains voltage range at full load and at half load, while it decreases at high mains at low load (70W). The THD has similar behavior, remaining within 25% overall the mains voltage range and increasing at low load (70 W) at high mains voltage.

Figure 8. Power factor vs. Vin & load

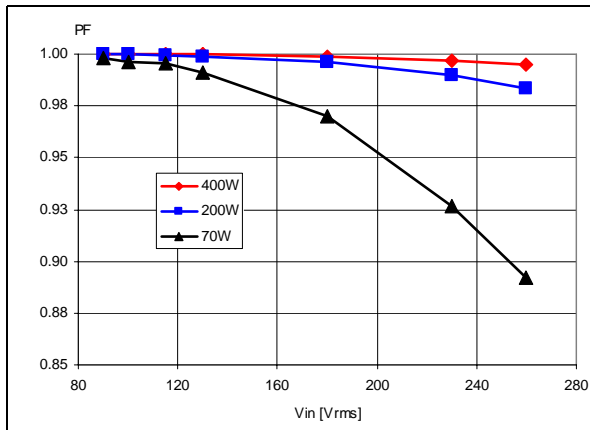
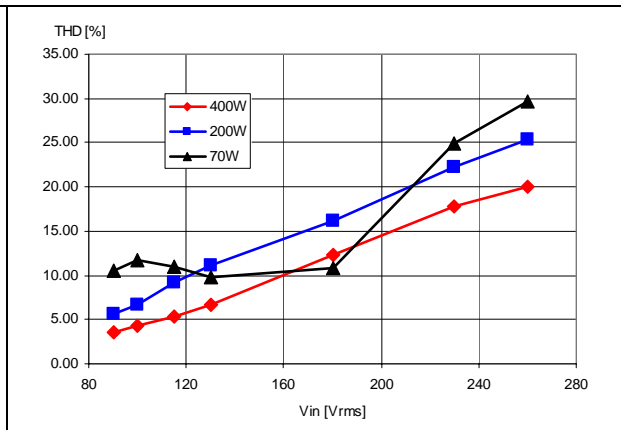

Figure 9. Total harmonic distortion vs. Vin & load



2.2 Efficiency measurements

Table 1. and Table 2. show the output voltage measurements at the nominal mains voltages of 115 V_{AC} and 230 V_{AC}, with different load conditions. For all measurements, both at full load and at light load operations, the input power is measured using a Yokogawa WT-210 digital power meter. Particular attention has to be paid when measuring input power at full load in order to avoid measurement errors due to the voltage drop on cables and connections.

Figure 10. shows the overall circuit efficiency, measured at each load condition, at both nominal input mains voltages of 115 V_{AC} and 230 V_{AC}. The values were measured after 30 minutes of warm-up at maximum load. The high efficiency of the PFC pre-regulator working in FOT mode and the very high efficiency of the resonant stage working in ZVS (i.e. with negligible switching losses), provides for an overall efficiency better than 88% at full load in the complete mains voltage range. This is a significant high value for a two-stage converter, especially at low input mains voltage where PFC conduction losses increase. Even at lower loads, the efficiency still remains high.

Figure 10. Overall efficiency versus output power at nominal mains voltages

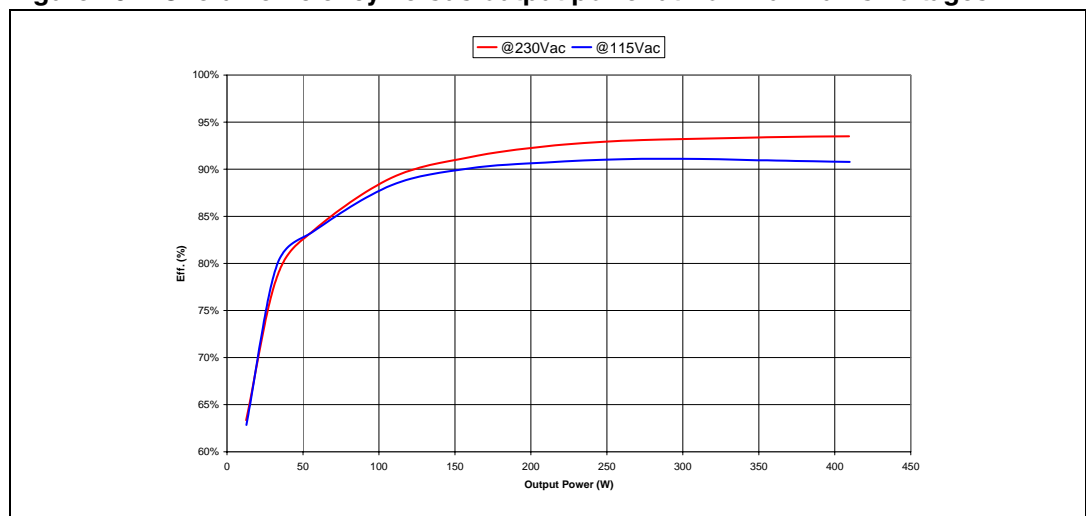

The global efficiency at full load has been measured even at the limits of the input voltage range, with good results:

At $V_{IN} = 90 V_{AC}$ - full load, the efficiency is 88.48%

At $V_{IN} = 264 V_{AC}$ - full load, the efficiency is 93.70%

Also at light load, at an output power of about 10% of the maximum level, the overall efficiency is very good, reaching a value better than 79% over the entire input mains voltage range. *Figure 11* shows the efficiency measured at various output power levels versus input mains voltage.

Table 1. Efficiency measurements @ $V_{IN} = 115 V_{AC}$

+200 V@load(A)		+5 V @load(A)		+3.3 V @load(A)		P _{OUT} (W)	P _{IN} (W)	Efficiency
202.50	1.989	4.84	0.968	3.33	0.695	409.77	451.38	90.78%
202.50	1.751	4.84	0.968	3.33	0.695	361.58	397.70	90.92%
202.50	1.501	4.84	0.968	3.33	0.695	310.95	341.39	91.08%
202.50	1.251	4.84	0.968	3.33	0.695	260.33	285.86	91.07%
202.50	1.000	4.84	0.968	3.33	0.695	209.50	230.96	90.71%
202.53	0.751	4.84	0.968	3.33	0.695	159.10	176.63	90.08%
202.53	0.500	4.84	0.968	3.33	0.695	108.26	122.62	88.29%
202.53	0.250	4.84	0.968	3.33	0.695	57.63	69.04	83.48%
202.56	0.150	4.84	0.293	3.33	0.309	32.83	41.14	79.80%
202.67	0.051	4.84	0.293	3.33	0.309	12.78	20.34	62.85%

Table 2. Efficiency measurements @ $V_{IN} = 230 V_{AC}$

+200 V@load(A)		+5 V @load(A)		+3.3 V @load(A)		P _{OUT} (W)	P _{IN} (W)	Efficiency
202.50	1.987	4.84	0.968	3.33	0.695	409.37	437.79	93.51%
202.50	1.750	4.84	0.968	3.33	0.695	361.37	386.90	93.40%
202.50	1.500	4.84	0.968	3.33	0.695	310.75	333.33	93.23%
202.50	1.250	4.84	0.968	3.33	0.695	260.12	279.65	93.02%
202.50	1.000	4.84	0.968	3.33	0.695	209.50	226.68	92.42%
202.50	0.750	4.84	0.968	3.33	0.695	158.87	174.10	91.25%
202.53	0.500	4.84	0.968	3.33	0.695	108.26	121.54	89.08%
202.53	0.250	4.84	0.968	3.33	0.695	57.63	68.96	83.57%
202.54	0.150	4.84	0.293	3.33	0.309	32.83	41.80	78.54%
202.67	0.050	4.84	0.293	3.33	0.309	12.58	19.86	63.35%

Figure 11. Overall efficiency versus input mains voltage at various output power levels

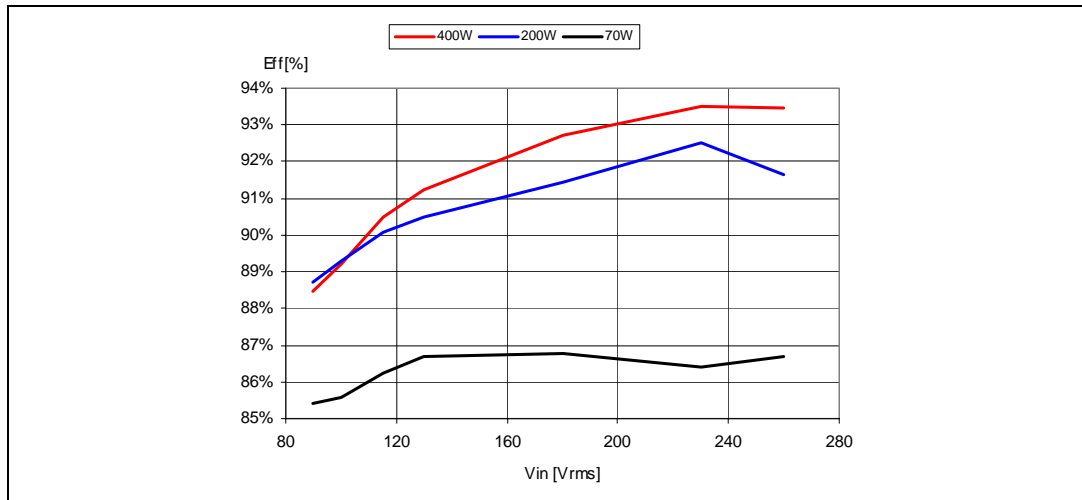

2.3 Resonant stage operating waveforms

Figure 12. shows some waveforms during steady state operation of the resonant circuit at full load. The Ch1 waveform is the half-bridge square voltage on Pin 14 of L6599, driving the resonant circuit. In the picture it is not evident, but the switching frequency is normally slightly modulated following the PFC pre-regulator 100-Hz ripple that is rejected by the resonant control circuitry. The Ch2 waveform represents the transformer primary current flowing into the resonant tank. As shown, it has almost a sinusoidal shape. The resonant tank has been designed (following the procedure presented in the application note AN2450) to operate at a resonance frequency of about 120 kHz when the dc input voltage of the half-bridge circuit is at 390 V (that is the nominal output voltage of the PFC stage).

The resonant frequency has been selected at approximately 120 kHz in order to have a good trade off between transformer losses and dimensions.

The resonant tank circuit has been designed in order to have a good margin for ZVS operation, providing good efficiency, while the almost sinusoidal current waveform allows for an extremely low EMI generation.

Figure 13. and *Figure 14.* shows the same waveforms as *Figure 12*, when the +200 V output is at a light load (about 30 W) or not loaded at all. These two graphics demonstrate the ability of the converter to operate down to zero load, with the output voltage still within the regulation range. The resonant tank current has a triangular shape and represents the magnetizing current flowing into the transformer primary side. The oscillation superimposed on the tank current depends on the occurrence of a further resonance due to the parallel of the inductances at primary side (the series and shunt inductances in the APR (all primary referred) transformer model presented in AN2450) and the undesired secondary side capacitance reflected at the transformer primary side.

Figure 12. Resonant circuit primary side waveforms at full load

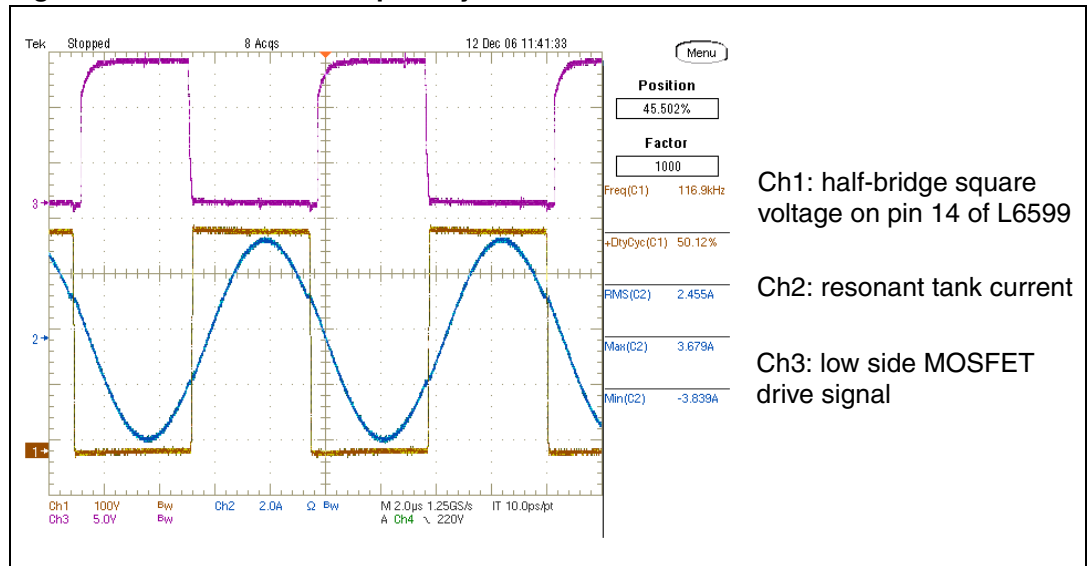

Figure 13. Resonant circuit primary side waveforms at light load (about 30 W output power)

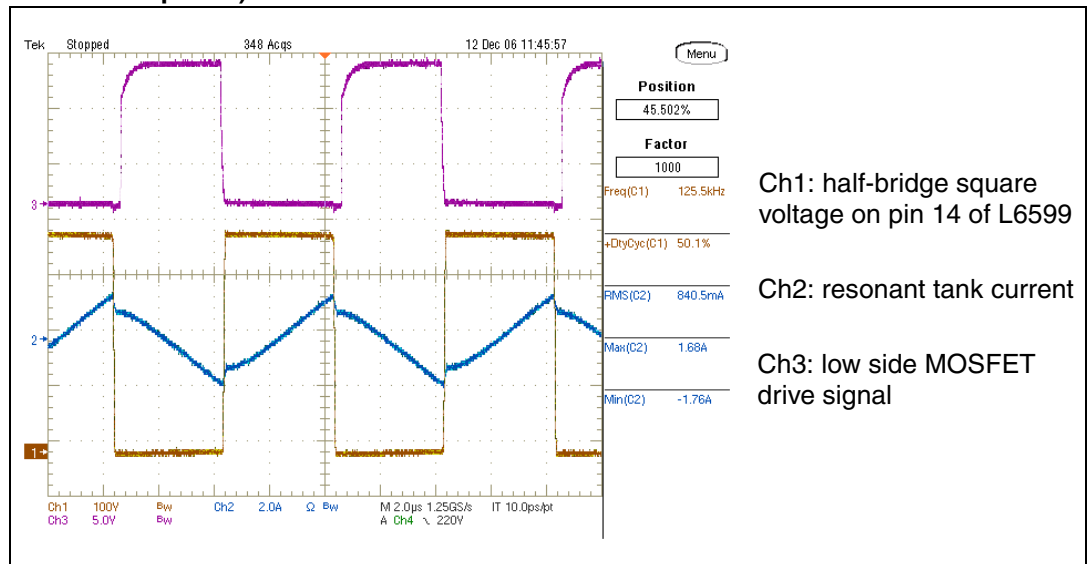
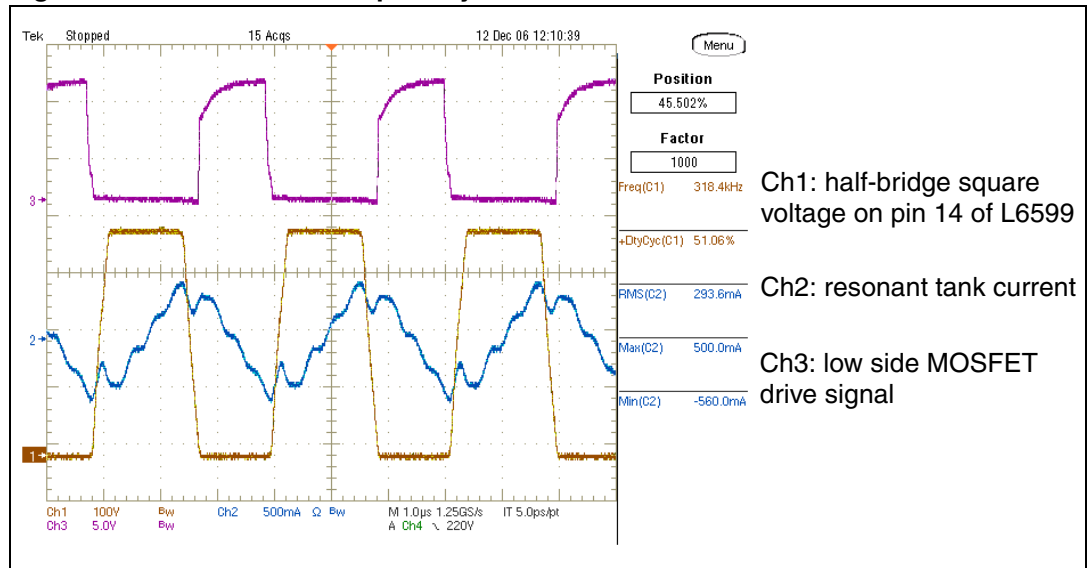

Figure 14. Resonant circuit primary side waveforms at no load condition



In [Figure 15.](#), waveforms relevant to the secondary side are represented. In particular, the waveform Ch1 is the voltage of D8A anode referenced to the secondary ground potential, while the waveform CH3 shows the current flowing into D8A-D10B diodes. Also this current waveform (like the one flowing into the resonant tank at the transformer primary side) has almost a sine shape, and its average value is one half the output average current.

Thanks to the advantages of the resonant converter, the high frequency noise on the output voltages is less than 50 mV, while the residual ripple at twice the mains frequency (100 Hz) is about 150 mV at maximum load and worse line condition (90 V_{AC}), as shown in [Figure 16.](#)

Figure 15. Resonant circuit secondary side waveforms: +200 V output

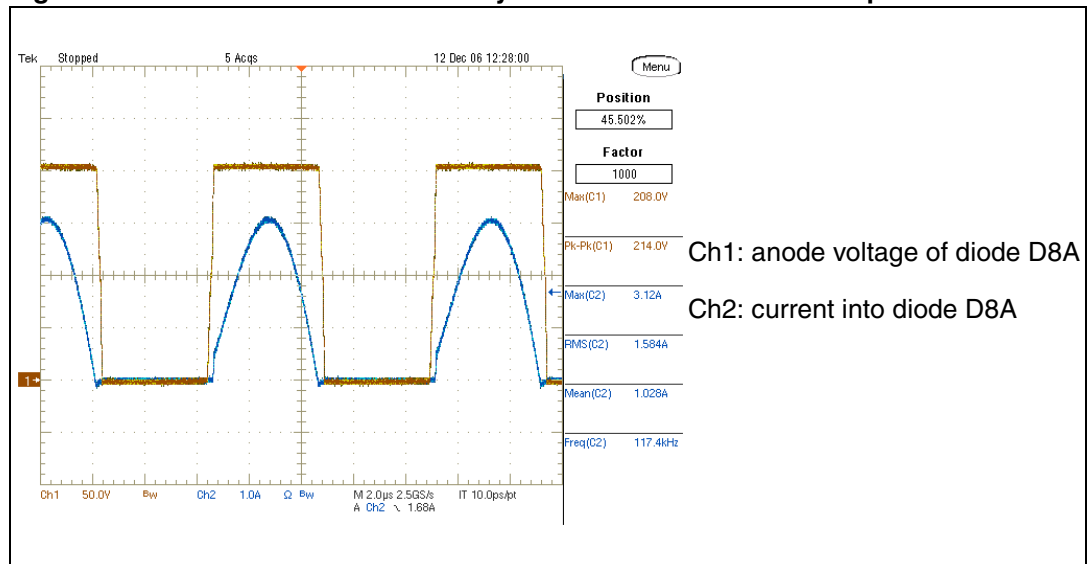

Figure 16. Low frequency (100 Hz) ripple voltage on the +200 V output

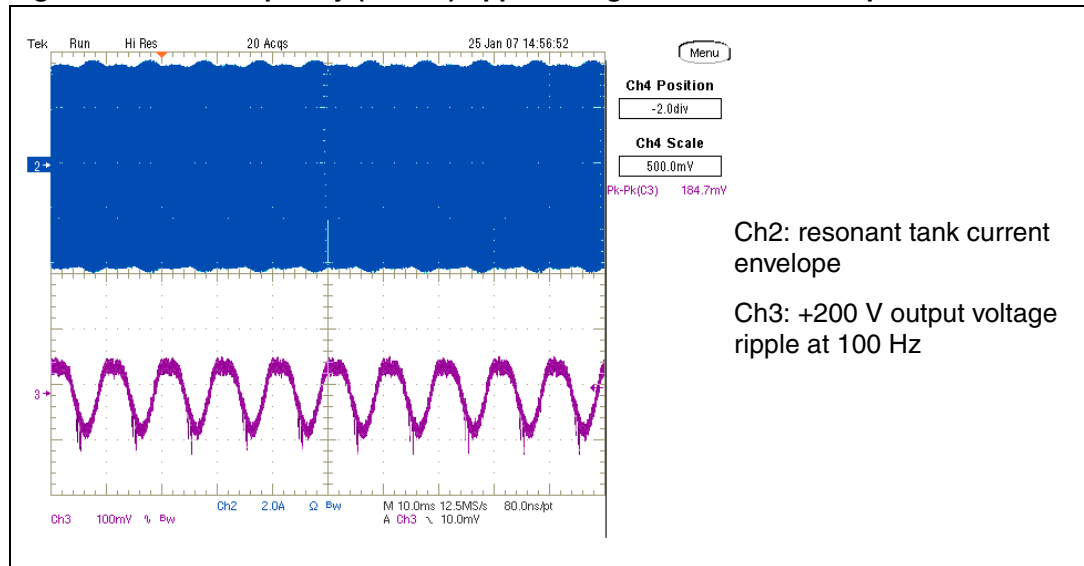
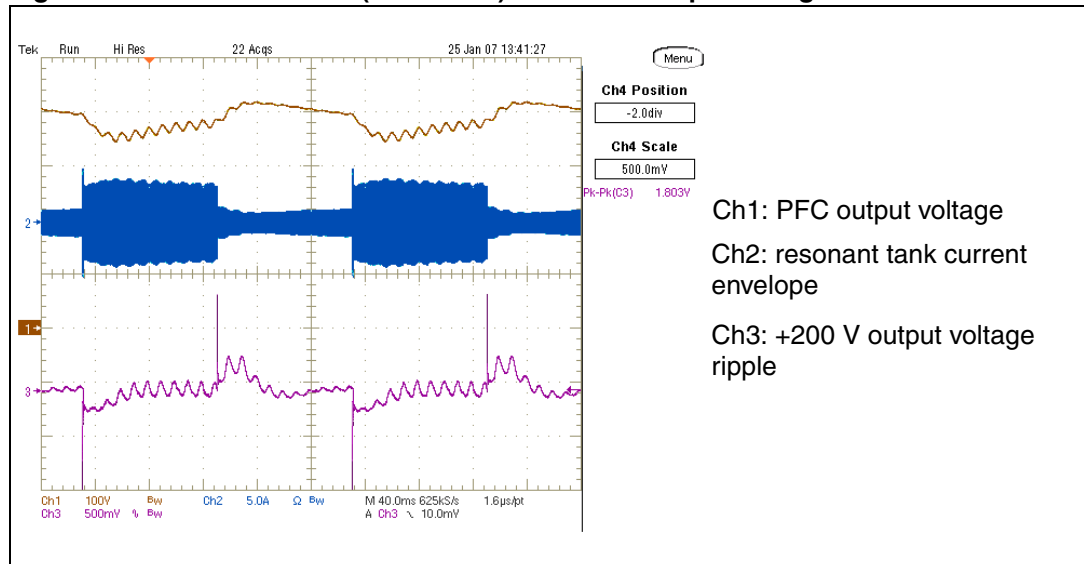

Figure 17. shows the dynamic behavior of the converter during a load variation from 20% to 100% on the +200 V output. This figure also highlights the induced effect of this load change on the PFC pre-regulator output voltage (+400 V on Ch1 track). Both the transitions (from 20% to 100% and from 100% to 20%) are clean and do not show any problem for the output voltage regulation.

This shows that the proposed architecture is also highly suitable for power supplies operating with strong load variation without any problems related to the load regulation.

Figure 17. Load transition (0.4 A - 2 A) on +200 V output voltage



2.4 Stand-by and no-load power consumption

The board is specifically designed for light load and zero load operations, typical conditions occurring during Stand-by or Power-off operations, when no power is requested from the

+200 V output. Though the resonant converter can operate down to zero load, some actions are required to keep the input power drawn from the mains very low when the complete system is in this load condition. Thus, when entering this power management mode, the ST-BY signal needs to be set high (by the microcontroller of the system). This forces the PFC pre-regulator and the resonant stage to switch off, because the supply voltage of the two control ICs is no longer present (*Figure 3*) and only the auxiliary flyback converter continues working just to supply the microprocessor circuitry.

Table 3. and *Table 4.* show the measurements of the input power in several light load conditions at 115 and 230 V_{AC}. These tables show that at no-load the input power is about 0.5 W.

Table 3. Stand-by consumption at VIN = 115 V_{AC}

+5 V @load(A)	+3.3 V @load(A)	P _{OUT} (W)	P _{IN} (W)
5.06 - 0.017	3.33 - 0.102	0.425	0.860
5.04 - 0.017	3.33 - 0.079	0.349	0.750
4.98 - 0.017	3.33 - 0.046	0.238	0.581
4.90 - 0.017	3.33 - 0.024	0.163	0.475
4.47 - 0.000	3.33 - 0.000	0.00	0.245

Table 4. Stand-by consumption at VIN = 230 V_{AC}

+5 V @load(A)	+3.3 V @load(A)	P _{OUT} (W)	P _{IN} (W)
5.06 - 0.017	3.33 - 0.102	0.425	1.156
5.04 - 0.017	3.33 - 0.079	0.349	1.044
4.98 - 0.017	3.33 - 0.046	0.238	0.870
4.90 - 0.017	3.33 - 0.024	0.163	0.755
4.47 - 0.000	3.33 - 0.000	0.00	0.510

2.5 Short-circuit protection

The L6599 is equipped with a current sensing input (pin 6, ISEN) and a dedicated overcurrent management system. The current flowing in the circuit is detected (through the not dissipative sensing circuit already mentioned in *Chapter 1*, mainly based on a capacitive divider formed by the resonant capacitor C28 and the capacitor C34, followed by an integration cell D12, R45, C39) and the signal is fed into the ISEN pin. This is internally connected to the input of a first comparator, referenced to 0.8 V, and to that of a second comparator referenced to 1.5 V. If the voltage externally applied to the ISEN pin exceeds 0.8 V, the first comparator is tripped causing an internal switch to be turned on discharging the soft-start capacitor CSS.

For output short-circuits, this operation results in a nearly constant peak primary current.

The designer can externally program the maximum time (t_{SH}) that the converter is allowed to run overloaded or under short-circuit conditions. Overloads or shortcircuits lasting less than t_{SH} will not cause any other action, hence providing the system with immunity to short duration phenomena. If, instead, t_{SH} is exceeded, an overload protection (OLP) procedure is

activated that shuts down the device and, in case of continuous overload/short circuit, results in continuous intermittent operation with a user-defined duty cycle. This function is accomplished by the DELAY pin 2 of the resonant controller, by means of the capacitor C24 and the parallel resistor R37 connected to ground. As the voltage on the ISEN pin exceeds 0.8V, the first OCP comparator, in addition to discharging CSS, turns on an internal current generator that via the DELAY pin charges C24. As the voltage on C24 reaches 3.5 V, the L6599 stops switching and the internal generator is turned off, so that C24 will now be slowly discharged by R37. The IC will restart when the voltage on C24 becomes less than 0.3 V. Additionally, if the voltage on the ISEN pin reaches 1.5 V for any reason (e.g. transformer saturation), the second comparator will be triggered, the device will shut down and the operation will be resumed after an on-off cycle. *Figure 18.* illustrates the short-circuit protection sequence described above. The on-off operation is controlled by the voltage on pin 2 (DELAY), providing for the hiccup mode of the circuit. Thanks to this control pin, the designer can select the hiccup mode timing and thus keep the average output current at a safe level.

Figure 18. +200 V output short-circuit waveforms

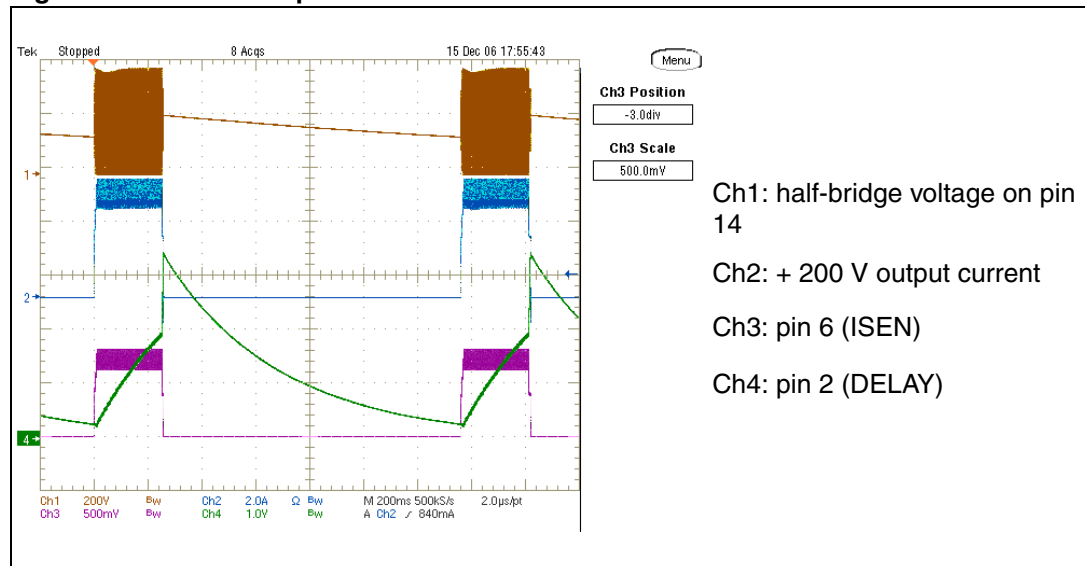

2.6 Overvoltage protection

Both the PFC pre-regulator and the resonant converter are equipped with their own overvoltage protection circuit. The PFC controller is internally equipped with a dynamic and a static overvoltage protection circuit sensing the current flowing through the error amplifier compensation network and entering in the COMP pin (#2). When this current reaches about 18 μA , the output voltage of the multiplier is forced to decrease, thus reducing the energy drawn from the mains. If the current exceeds 20 μA , the OVP is triggered (Dynamic OVP), and the external power transistor is switched off until the current falls approximately below 5 μA . However, if the overvoltage persists (e.g. in case the load is completely disconnected), the error amplifier will eventually saturate low, triggering an internal comparator (Static OVP) that will keep the external power switch turned off until the output voltage comes back close to the regulated value. Moreover, in the L6563 there is additional protection against loop failures using an additional divider (R5, R7, R9, R16 and R25) connected to a dedicated pin (PFC_OK, Pin 7) protecting the circuit in case of loop failures, disconnection, or deviation from the nominal value of the feedback loop divider. Hence the PFC output voltage is always

under control and if a fault condition is detected, the PFC_OK circuitry will latch the PFC operation and, by means of the PWM_LATCH pin 8 it will also latch the L6599 via the DIS pin of the resonant controller.

The OVP circuit (see [Figure 3](#)) for the output voltages of the resonant converter uses a resistive divider (R75, R76, R80) and the zener diode D21 to sense the +200 V output: if the sensed voltage exceeds the threshold imposed by the zener diode plus the VBE of Q10, the transistor Q9 starts conducting and the optocoupler U8 opens Q7, so that the VAUX supply voltage of the controller ICs L6563 and L6599 is no longer available. This state is latched until a mains voltage recycle occurs.

3 Thermal tests

In order to check design reliability, a thermal mapping by an IR Camera was performed. [Figure 19](#) and [Figure 20](#) show the thermal measurements of the board, component side, at nominal input voltage. The correlation between measurement points and components is indicated for both diagrams in [Table 5](#).

All other board components work well within the temperature limits, assuring a reliable long term operation of the power supply.

Note that the temperatures of L4 and T1 have been measured both on the ferrite core (Fe) and on the copper winding (Cu).

Table 5. Key components temperature at nominal voltages and full load

Point	Item	230 V _{AC}	115 V _{AC}
A	D2	40,3°C	47,6°C
B	L4-(FE)	44,2°C	50,5°C
C	L4-(CU)	46,0°C	55,5°C
D	Q1	44,5°C	53,4°C
E	R2	63,5°C	73,0°C
F	D3	46,1°C	51,0°C
G	C8	39,3°C	40,1°C
H	Q6	51,4°C	52,8°C
I	T1-(CU)	63,7°C	62,6°C
J	T1-(FE)	51,3°C	49,6°C
K	U5	53,2°C	53,4°C
L	D14	51,8°C	52,3°C
M	C38	39,4°C	38,5°C
N	C45	36,1°C	35,7°C
O	D8A	44,5°C	44,9°C
P	R22	41,4°C	55,6°C

Table 5. Key components temperature at nominal voltages and full load

Point	Item	230 V _{AC}	115 V _{AC}
Q	D15	43,3°C	43,5°C
R	D16	42,6°C	42,1°C
S	T2	43,3°C	43,6°C

Figure 19. Thermal map @115 V_{AC} - full load

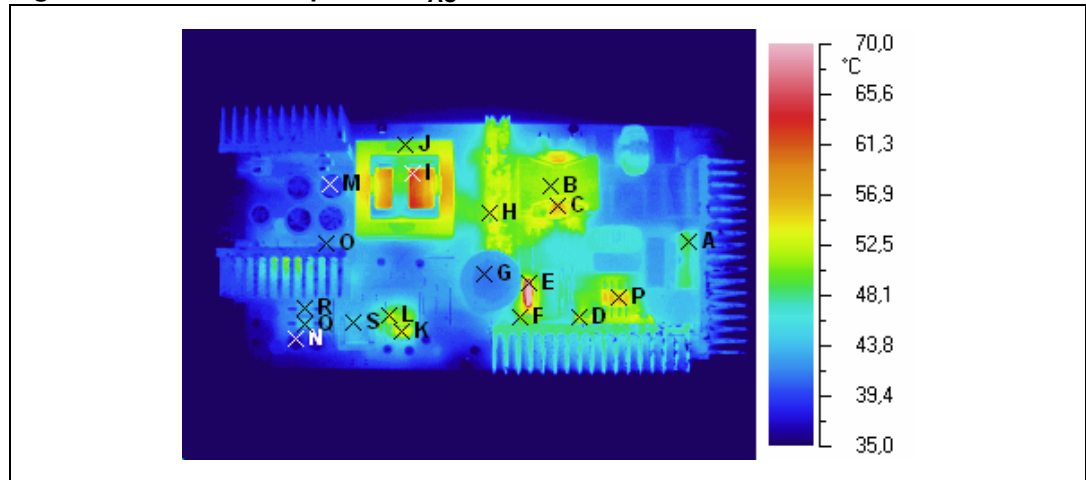
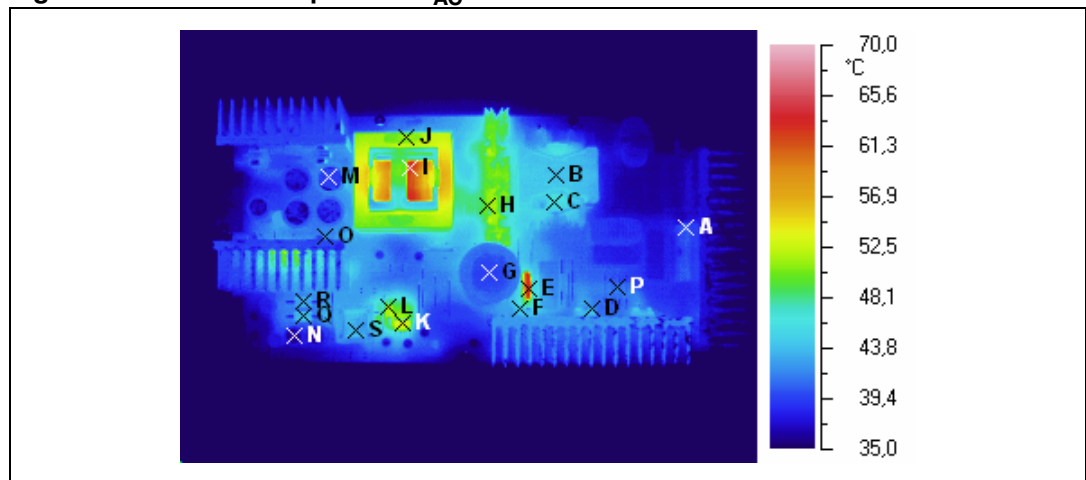

Figure 20. Thermal map at 230 V_{AC} - full load



4 Conducted emission pre-compliance test

The measurements have been taken in peak detection mode, both on LINE and on Neutral at nominal input mains and at full load. The limits indicated on the following diagrams refer to the EN55022 Class- B specifications (the higher limit curve is the quasi-peak limit while the lower curve is the average limit) and the measurements show that the PSU emission is well below the maximum allowed limit.

Figure 21. Peak measurement on LINE at 115 V_{AC} and full load

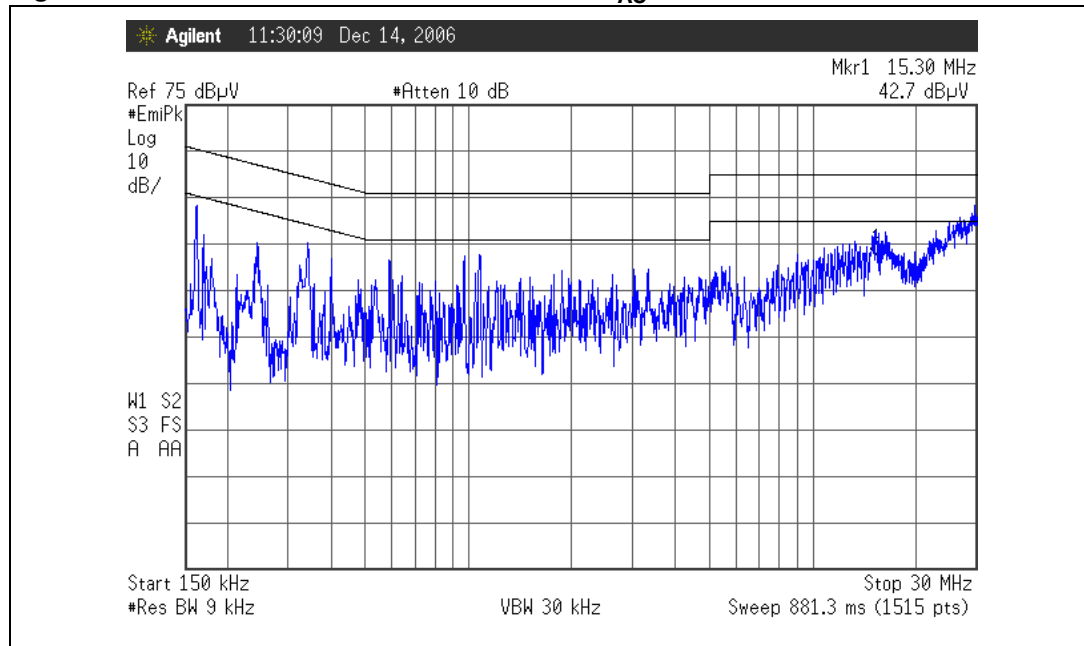

Figure 22. Peak measurement on NEUTRAL at 115 V_{AC} and full load

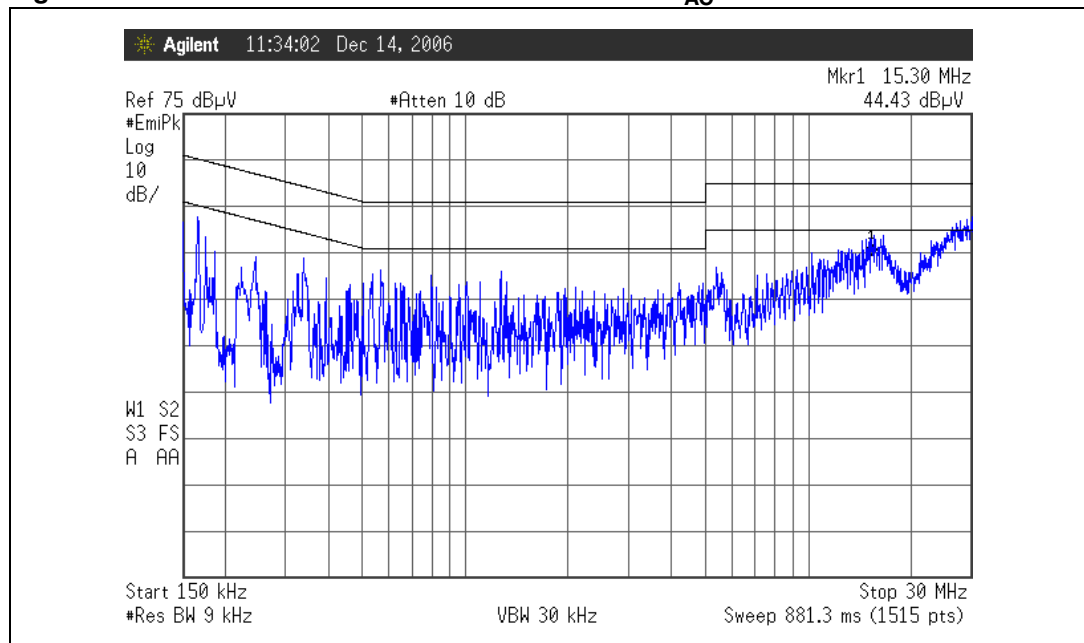

Figure 23. Peak measurement on LINE at 230 V_{AC} and full load

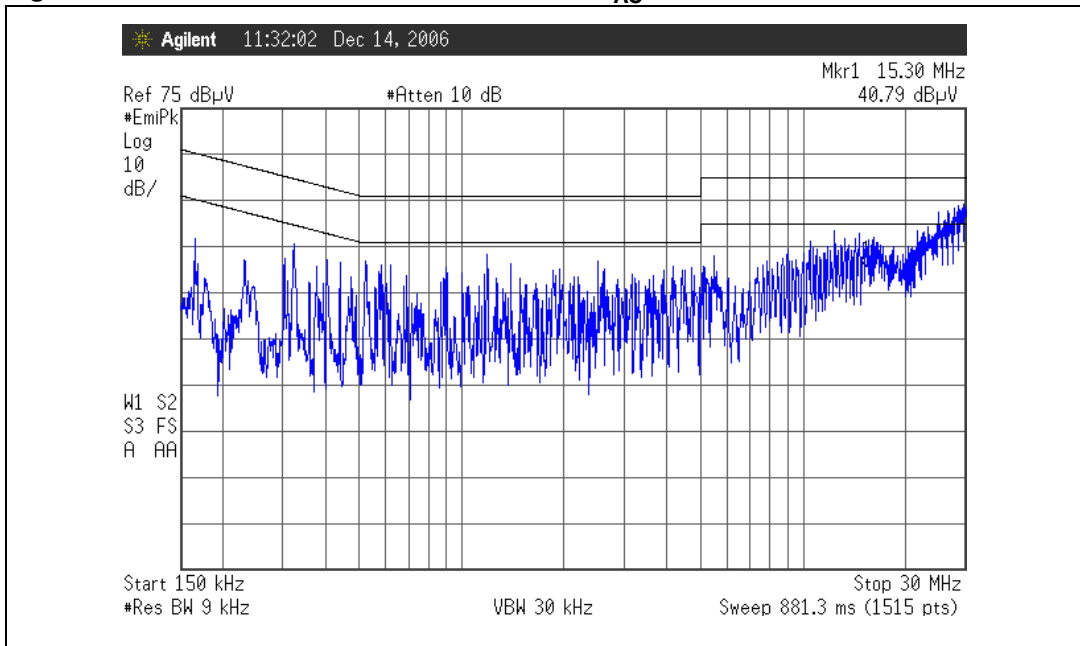
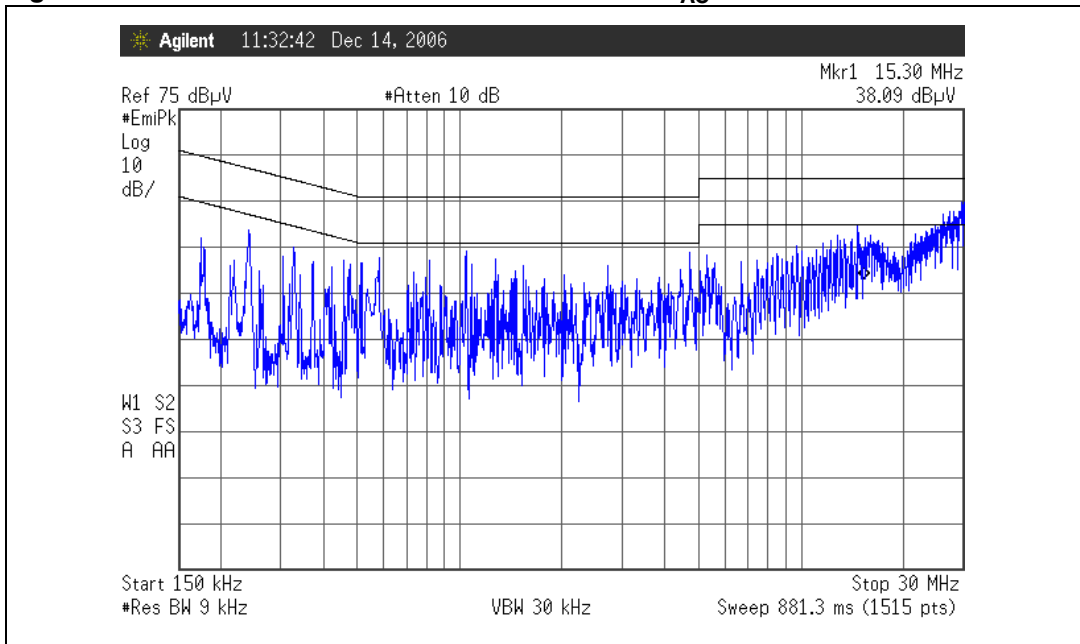

Figure 24. Peak measurement on NEUTRAL at 230 V_{AC} and full load



5 Bill of materials

Table 6. Bill of materials

Item	Part	Description	Supplier
C2	470 nF-X2	275 V _{AC} X2 SAFETY CAPACITOR MKP R46	ARCOTRONICS
C3	330 nF-X2	275 V _{AC} X2 SAFETY CAPACITOR MKP R46	ARCOTRONICS
C4	680 nF-X2	27 5 V _{AC} X2 SAFETY CAPACITOR MKP R46	ARCOTRONICS
C5	470 nF/630 V	POLYPROPYLENE CAPACITOR HIGH RIPPLE MKP R71	ARCOTRONICS - EPCOS
C6	470 nF/630 V	POLYPROPYLENE CAPACITOR HIGH RIPPLE MKP R71	ARCOTRONICS - EPCOS
C7	470 nF/630 V	POLYPROPYLENE CAPACITOR HIGH RIPPLE MKP R71	ARCOTRONICS - EPCOS
C8	330 µF/450 V	ALUMINIUM ELCAP USC SERIES 85 DEG SNAP-IN	RUBYCON
C9	2 nF2-Y1	400 V _{AC} Y1 SAFETY CERAMIC DISK CAPACITOR	MURATA
C10	2 nF2-Y1	250 V _{AC} Y1 SAFETY CERAMIC DISK CAPACITOR	MURATA
C11	2 nF2-Y1	250 V _{AC} Y1 SAFETY CERAMIC DISK CAPACITOR	MURATA
C12	100 nF	50 V 1206 SMD CERCAP GENERAL PURPOSE	AVX
C13	10 µF/50 V	ALUMINIUM ELCAP GENERAL PURPOSE 85 DEG	RUBYCON
C14	100 nF	50 V 1206 SMD CERCAP GENERAL PURPOSE	AVX
C15	100 pF	100 V 0805 SMD CERCAP GENERAL PURPOSE	AVX
C16	1 µF	25 V 1206 SMD CERCAP GENERAL PURPOSE	AVX
C17	220 pF	100 V 0805 SMD CERCAP GENERAL PURPOSE	AVX
C18	330 pF	100 V 0805 SMD CERCAP GENERAL PURPOSE	AVX
C19	10 nF	100 V 0805 SMD CERCAP GENERAL PURPOSE	AVX
C20	470 nF	50 V 1206 SMD CERCAP GENERAL PURPOSE	AVX
C21	2 nF2	100 V 1206 SMD CERCAP GENERAL PURPOSE	AVX
C22	10 nF	100 V 0805 SMD CERCAP GENERAL PURPOSE	AVX
C23	4 µF7	16 V 1206 SMD CERCAP GENERAL PURPOSE	AVX
C24	470 nF	25 V 1206 SMD CERCAP GENERAL PURPOSE	AVX
C25	22 µF/250 V	ALUMINIUM ELCAP YXF SERIES 105 DEG	RUBYCON
C26	270 pF	100 V 0805 SMD CERCAP GENERAL PURPOSE	AVX
C27	100 nF	50 V 1206 SMD CERCAP GENERAL PURPOSE	AVX
C28	47 nF/630 V	POLYPROPYLENE CAPACITOR HIGH RIPPLE PHE450	RIFA-EVOX
C29	100 µF/250 V	ALUMINIUM ELCAP YXF SERIES 105 DEG	RUBYCON
C30	100 µF/250 V	ALUMINIUM ELCAP YXF SERIES 105 DEG	RUBYCON
C31	10 µF/50 V	ALUMINIUM ELCAP GENERAL PURPOSE 85 DEG	RUBYCON
C32	100 nF	50 V 1206 SMD CERCAP GENERAL PURPOSE	AVX
C33	4 nF7	100 V 1206 SMD CERCAP GENERAL PURPOSE	AVX

Table 6. Bill of materials (continued)

Item	Part	Description	Supplier
C34	220 pF/630 V	POLYPROPYLENE CAPACITOR HIGH RIPPLE PFR	RIFA-EVOX
C37	100 µF/250 V	ALUMINIUM ELCAP YXF SERIES 105 DEG	RUBYCON
C38	100 µF/250 V	ALUMINIUM ELCAP YXF SERIES 105 DEG	RUBYCON
C39	1 µF0	25 V 1206 SMD CERCAP GENERAL PURPOSE	AVX
C40	10 nF	100 V 1206 SMD CERCAP GENERAL PURPOSE	AVX
C41	10 µF/50 V	ALUMINIUM ELCAP GENERAL PURPOSE 85 DEG	RUBYCON
C44	47 nF	100 V 1206 SMD CERCAP GENERAL PURPOSE	AVX
C45	1000 µF/10 V	ALUMINIUM ELCAP YXF SERIES 105 DEG	RUBYCON
C46	100 µF/10 V	ALUMINIUM ELCAP YXF SERIES 105 DEG	RUBYCON
C47	1000 µF/10 V	ALUMINIUM ELCAP YXF SERIES 105 DEG	RUBYCON
C48	10 µF/50 V	ALUMINIUM ELCAP GENERAL PURPOSE 85 DEG	RUBYCON
C49	100 µF/10 V	ALUMINIUM ELCAP YXF SERIES 105 DEG	RUBYCON
C50	10 µF/50 V	ALUMINIUM ELCAP GENERAL PURPOSE 85 DEG	RUBYCON
C51	100 nF	100 V 0805 SMD CERCAP GENERAL PURPOSE	AVX
C52	47 nF	100 V 0805 SMD CERCAP GENERAL PURPOSE	AVX
C53	2 nF2	100 V 0805 SMD CERCAP GENERAL PURPOSE	AVX
C54	100 nF	50 V 1206 SMD CERCAP GENERAL PURPOSE	AVX
C55	10 µF/50 V	ALUMINIUM ELCAP GENERAL PURPOSE 85 DEG	RUBYCON
C56	100 nF	50 V 1206 SMD CERCAP GENERAL PURPOSE	AVX
C57	1 nF0	100 V 0805 SMD CERCAP GENERAL PURPOSE	AVX
C58	10 nF	50 V X7R STANDARD CERAMIC CAPACITOR	AVX
C59	47 nF/250 V	POLCAP PHE426 SERIES	RIFA-EVOX
C60	470 nF	25 V 1206 SMD CERCAP GENERAL PURPOSE	VISHAY
D1	1N5406	GENERAL PURPOSE RECTIFIER	VISHAY
D2	D15XB60	SINGLE PHASE BRIDGE RECTIFIER	SHINDENGEN
D3	STTH8R06	TO220FP ULTRAFAST HIGH VOLTAGE RECTIFIER	STMicroelectronics
D4	LL4148	MINIMELF FAST SWITCHING DIODE	VISHAY
D5	LL4148	MINIMELF FAST SWITCHING DIODE	VISHAY
D6	LL4148	MINIMELF FAST SWITCHING DIODE	VISHAY
D7	LL4148	MINIMELF FAST SWITCHING DIODE	VISHAY
D8A	STTH803	TO220FP ULTRAFAST HIGH VOLTAGE RECTIFIER	STMicroelectronics
D8B	STTH803	TO220FP ULTRAFAST HIGH VOLTAGE RECTIFIER	STMicroelectronics
D9	LL4148	MINIMELF FAST SWITCHING DIODE	VISHAY
D10A	STTH803	TO220FP ULTRAFAST MEDIUM VOLTAGE RECTIFIER	STMicroelectronics
D10B	STTH803	TO220FP ULTRAFAST MEDIUM VOLTAGE RECTIFIER	STMicroelectronics

Table 6. Bill of materials (continued)

Item	Part	Description	Supplier
D11	LL4148	MINIMELF FAST SWITCHING DIODE	VISHAY
D12	LL4148	MINIMELF FAST SWITCHING DIODE	VISHAY
D13	C-12 V	BZV55-C SERIES ZENER DIODE	VISHAY
D14	PKC-136	PEAK CLAMP TRANSIL	STMicroelectronics
D15	1N5822	POWER SCHOTTKY RECTIFIER	STMicroelectronics
D16	1N5821	POWER SCHOTTKY RECTIFIER	STMicroelectronics
D17	LL4148	MINIMELF FAST SWITCHING DIODE	VISHAY
D18	B-10 V	BZV55-B SERIES ZENER DIODE	VISHAY
D19	C-30 V	BZV55-C SERIES ZENER DIODE	VISHAY
D20	BAV103	GENERAL PURPOSE DIODE	VISHAY
D22	C-15 V	BZV55-C SERIES ZENER DIODE	VISHAY
F1	8 A/250 V	T TYPE FUSE 5 X 20 HIGH CAPABILITY & FUSEHOLDER	WICKMANN
J1	CON2-IN	3 PINS CONN. (CENTRAL REMOVED) P 3.96 KK SERIES	MOLEX
J2	CON8	8 PINS CONNECTOR P 3.96 KK SERIES	MOLEX
J3	CON10	10 PINS CONNECTOR P 2.54 MTA SERIES	AMP
L1	CM-1.5 mH-5 A	LFR2205B SERIES COMMON MODE INDUCTOR	DELTA
L2	CM-10 mH-5 A	TF3524 SERIES COMMON MODE TOROIDAL INDUCTOR	TDK
L3	DM-51 µH-6 A	LSR2306-1 DIFFERENTIAL MODE TOROIDAL INDUCTOR	DELTA
L4	PQ40-500 µH	86H-5410B BOOST INDUCTOR	DELTA
L5	10 µH	ELC08 DRUM CORE INDUCTOR	PANASONIC
L7	33 µH	ELC08 DRUM CORE INDUCTOR	PANASONIC
L8	33 µH	ELC08 DRUM CORE INDUCTOR	PANASONIC
Q1	STP12NM50FP	TO220FP N-CHANNEL Power MOSFET	STMicroelectronics
Q2	STP12NM50FP	TO220FP N-CHANNEL Power MOSFET	STMicroelectronics
Q3	BC857C	SOT23 SMALL SIGNAL PNP TRANSISTOR	STMicroelectronics
Q5	STP14NK50Z	TO220FP N-CHANNEL Power MOSFET	STMicroelectronics
Q6	STP14NK50Z	TO220FP N-CHANNEL Power MOSFET	STMicroelectronics
Q7	BC547C	TO92 SMALL SIGNAL PNP TRANSISTOR	STMicroelectronics
Q8	BC847C	SOT23 SMALL SIGNAL PNP TRANSISTOR	STMicroelectronics
Q9	BC857C	SOT23 SMALL SIGNAL PNP TRANSISTOR	STMicroelectronics
Q10	BC847C	SOT23 SMALL SIGNAL NPN TRANSISTOR	STMicroelectronics
Q11	BC547C	TO92 SMALL SIGNAL PNP TRANSISTOR	STMicroelectronics
R1	1M5	VR25 TYPE HIGH VOLTAGE RESISTOR	BC COMPONENTS
R2	NTC 2R5-S237	NTC RESISTOR 2R5 S237 SERIES	EPCOS

Table 6. Bill of materials (continued)

Item	Part	Description	Supplier
R3	680 k	1206 SMD STANDARD FILM RES 1/4 W 5% 200 ppm/°C	BC COMPONENTS
R4	47	0805 SMD STANDARD FILM RES 1/8 W 5% 200 ppm/°C	BC COMPONENTS
R5	2M2	1206 SMD STANDARD FILM RES 1/4 W 1% 100 ppm/°C	BC COMPONENTS
R6	680 k	1206 SMD STANDARD FILM RES 1/4 W 5% 200 ppm/°C	BC COMPONENTS
R7	2M2	1206 SMD STANDARD FILM RES 1/4 W 1% 100 ppm/°C	BC COMPONENTS
R8	680 k	1206 SMD STANDARD FILM RES 1/4 W 5% 200 ppm/°C	BC COMPONENTS
R9	2M2	1206 SMD STANDARD FILM RES 1/4 W 1% 100 ppm/°C	BC COMPONENTS
R10	100 k	0805 SMD STANDARD FILM RES 1/8 W 5% 200 ppm/°C	BC COMPONENTS
R11	15 k	0805 SMD STANDARD FILM RES 1/8 W 5% 200 ppm/°C	BC COMPONENTS
R13	56 k	1206 SMD STANDARD FILM RES 1/8 W 5% 200 ppm/°C	BC COMPONENTS
R14	3k3	0805 SMD STANDARD FILM RES 1/8 W 1% 100 ppm/°C	BC COMPONENTS
R15	6R8	0805 SMD STANDARD FILM RES 1/8 W 5% 200 ppm/°C	BC COMPONENTS
R16	5k1	1206 SMD STANDARD FILM RES 1/4 W 1% 100 ppm/°C	BC COMPONENTS
R17	15 k	0805 SMD STANDARD FILM RES 1/8 W 1% 100 ppm/°C	BC COMPONENTS
R18	6R8	0805 SMD STANDARD FILM RES 1/8 W 5% 200 ppm/°C	BC COMPONENTS
R19	1k0	0805 SMD STANDARD FILM RES 1/8 W 5% 200 ppm/°C	BC COMPONENTS
R20	1k0	STANDARD METAL FILM RES 1/4 W 5% 200 ppm/°C	BC COMPONENTS
R21	0R39	PR02 POWER RESISTOR	BC COMPONENTS
R22	0R39	PR02 POWER RESISTOR	BC COMPONENTS
R23	0R39	PR02 POWER RESISTOR	BC COMPONENTS
R24	0R39	PR02 POWER RESISTOR	BC COMPONENTS
R25	30 k	0805 SMD STANDARD FILM RES 1/8 W 1% 100 ppm/°C	BC COMPONENTS
R26	150 k	1206 SMD STANDARD FILM RES 1/8 W 5% 200 ppm/°C	BC COMPONENTS
R28	240 k	0805 SMD STANDARD FILM RES 1/8 W 5% 200 ppm/°C	BC COMPONENTS
R29	1k5	0805 SMD STANDARD FILM RES 1/8 W 5% 200 ppm/°C	BC COMPONENTS
R30	620 k	1206 SMD STANDARD FILM RES 1/4 W 5% 200 ppm/°C	BC COMPONENTS
R31	620 k	1206 SMD STANDARD FILM RES 1/4 W 5% 200 ppm/°C	BC COMPONENTS
R32	10 k	0805 SMD STANDARD FILM RES 1/8 W 5% 200 ppm/°C	BC COMPONENTS
R33	0R	0805 SMD STANDARD FILM RES 1/8 W	BC COMPONENTS
R34	3k9	0805 SMD STANDARD FILM RES 1/8 W 5% 200 ppm/°C	BC COMPONENTS
R35	47	0805 SMD STANDARD FILM RES 1/8 W 5% 200 ppm/°C	BC COMPONENTS
R36	0R	0805 SMD STANDARD FILM RES 1/8 W	BC COMPONENTS
R37	1M0	0805 SMD STANDARD FILM RES 1/8 W 5% 200 ppm/°C	BC COMPONENTS
R38	47	STANDARD METAL FILM RES 1/4 W 5% 200 ppm/°C	BC COMPONENTS
R39	0R	0805 SMD STANDARD FILM RES 1/8 W	BC COMPONENTS

Table 6. Bill of materials (continued)

Item	Part	Description	Supplier
R40	47	0805 SMD STANDARD FILM RES 1/8 W 5% 200 ppm/°C	BC COMPONENTS
R41	16 k	0805 SMD STANDARD FILM RES 1/8 W 1% 100 ppm/°C	BC COMPONENTS
R42	10	1206 SMD STANDARD FILM RES 1/8 W 5% 200 ppm/°C	BC COMPONENTS
R43	150	1206 SMD STANDARD FILM RES 1/4 W 5% 200ppm/°C	BC COMPONENTS
R45	75R	1206 SMD STANDARD FILM RES 1/4 W 1% 100 ppm/°C	BC COMPONENTS
R46	1k5	0805 SMD STANDARD FILM RES 1/8 W 5% 200 ppm/°C	BC COMPONENTS
R47	10 k	1206 SMD STANDARD FILM RES 1/8 W 5% 200 ppm/°C	BC COMPONENTS
R48	330 k	1206 SMD STANDARD FILM RES 1/4 W 5% 200 ppm/°C	BC COMPONENTS
R49	330 k	1206 SMD STANDARD FILM RES 1/4 W 5% 200 ppm/°C	BC COMPONENTS
R50	330 k	1206 SMD STANDARD FILM RES 1/4 W 5% 200 ppm/°C	BC COMPONENTS
R51	330 k	0805 SMD STANDARD FILM RES 1/8 W 5% 200 ppm/°C	BC COMPONENTS
R52	3k3	0805 SMD STANDARD FILM RES 1/8 W 5% 200 ppm/°C	BC COMPONENTS
R53	75 k	1206 SMD STANDARD FILM RES 1/4 W 1% 100 ppm/°C	BC COMPONENTS
R54	1k5	0805 SMD STANDARD FILM RES 1/8 W 5% 200 ppm/°C	BC COMPONENTS
R56	1k0	0805 SMD STANDARD FILM RES 1/8 W 5% 200 ppm/°C	BC COMPONENTS
R58	75k	1206 SMD STANDARD FILM RES 1/4 W 1% 100 ppm/°C	BC COMPONENTS
R59	1k0	0805 SMD STANDARD FILM RES 1/8 W 5% 200 ppm/°C	BC COMPONENTS
R60	12 k	0805 SMD STANDARD FILM RES 1/8 W 1% 100 ppm/°C	BC COMPONENTS
R61	2k2	0805 SMD STANDARD FILM RES 1/8 W 1% 100 ppm/°C	BC COMPONENTS
R62	47	0805 SMD STANDARD FILM RES 1/8 W 5% 200 ppm/°C	BC COMPONENTS
R64	1k6	0805 SMD STANDARD FILM RES 1/8 W 1% 100 ppm/°C	BC COMPONENTS
R66	1k0	0805 SMD STANDARD FILM RES 1/8 W 5% 200 ppm/°C	BC COMPONENTS
R67	1k0	0805 SMD STANDARD FILM RES 1/8 W 5% 200 ppm/°C	BC COMPONENTS
R68	22 k	0805 SMD STANDARD FILM RES 1/8 W 5% 200 ppm/°C	BC COMPONENTS
R69	0R	0805 SMD STANDARD FILM RES 1/8 W 5% 200 ppm/°C	BC COMPONENTS
R70	22R	0805 SMD STANDARD FILM RES 1/8 W 5% 200 ppm/°C	BC COMPONENTS
R71	10 k	0805 SMD STANDARD FILM RES 1/8 W 5% 200 ppm/°C	BC COMPONENTS
R72	10 k	0805 SMD STANDARD FILM RES 1/8 W 5% 200 ppm/°C	BC COMPONENTS
R73	8k2	0805 SMD STANDARD FILM RES 1/8 W 5% 200 ppm/°C	BC COMPONENTS
R74	10 k	0805 SMD STANDARD FILM RES 1/8 W 5% 200 ppm/°C	BC COMPONENTS
R75	150 k	1206 SMD STANDARD FILM RES 1/4 W 1% 100 ppm/°C	BC COMPONENTS
R76	150 k	1206 SMD STANDARD FILM RES 1/4 W 1% 100 ppm/°C	BC COMPONENTS
R77	4k7	0805 SMD STANDARD FILM RES 1/8 W 1% 100 ppm/°C	BC COMPONENTS
R79	2k2	0805 SMD STANDARD FILM RES 1/8 W 5% 200 ppm/°C	BC COMPONENTS
R80	30 k	0805 SMD STANDARD FILM RES 1/8 W 1% 100 ppm/°C	BC COMPONENTS

Table 6. Bill of materials (continued)

Item	Part	Description	Supplier
R83	1M0	VR25 TYPE HIGH VOLTAGE RESISTOR	BC COMPONENTS
R84	150 k	STANDARD METAL FILM RES 1/4 W 5% 200 ppm/°C	BC COMPONENTS
R85	120 k	STANDARD METAL FILM RES 1/4 W 5% 200 ppm/°C	BC COMPONENTS
R86	470R	0805 SMD STANDARD FILM RES 1/8 W 5% 200 ppm/°C	BC COMPONENTS
R87	220R	STANDARD METAL FILM RES 1/4 W 5% 200 ppm/°C	BC COMPONENTS
T1	T-RES-ER49-400 W	86H-6412 TYPE RESONANT TRANSFORMER ER49	DELTA
T2	T-FLY-AUX-E20	86A-6079-R TYPE FLYBACK TRANSFORMER E20 CORE	DELTA
U1	L6563	ADVANCED TRANSITION MODE PFC CONTROLLER	STMicroelectronics
U2	L6599	HIGH VOLTAGE RESONANT CONTROLLER	STMicroelectronics
U3	SFH617A-2	63-125% CTR SELECTION OPTOCOUPLER	INFINEON
U4	TL431	TO92 PROGRAMMABLE SHUNT VOLTAGE REGULATOR	STMicroelectronics
U5	VIPer12A	LOW POWER OFF LINE SMPS PRIMARY SWITCHER	STMicroelectronics
U6	SFH617A-2	63-125% CTR SELECTION OPTOCOUPLER	INFINEON
U7	TL431	TO92 PROGRAMMABLE SHUNT VOLTAGE REGULATOR	STMicroelectronics
U8	SFH617A-2	63-125% CTR SELECTION OPTOCOUPLER	INFINEON

Note: Q9 and R72: mounted by reworking on PCB

Q11, R83, R84, R85, R86, R87, C58, C59 and C60: added by reworking on PCB

6 PFC coil specification

- Application type: consumer, home appliance
- Inductor type: open
- Coil former: vertical type, 6+6 pins
- Max. temp. rise: 45 °C
- Max. operating ambient temp.: 60 °C

6.1 Electrical characteristics

- Converter topology: FOT PFC Preregulator
- Core type: PQ40-30 material grade PC44 or equivalent
- Max operating freq: 100 KHz
- Primary inductance: 500 μH ±10% @ 1 KHz-0.25 V (see [Note: 1](#))
- Primary RMS current: 4.75 A

Note: 1 Measured between pins 2-3 and 10-11

Figure 25. Electrical diagram

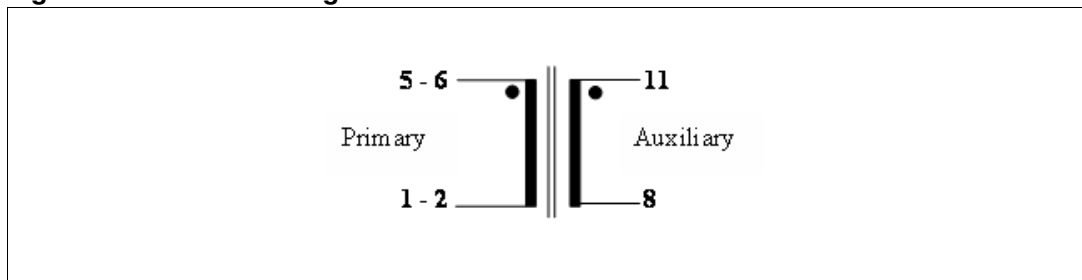

2 The auxiliary winding is not used in this design, but is foreseen for another application

Table 7. Winding characteristics

Start PINS	End PINS	Number of turns	Wire type	Wire diameter	Notes
11	8	5 (spaced)	Single	Ø 0.28 mm	Bottom
5 - 6	1 - 2	65	Multistrand – G2	Litz Ø 0.2 mm x 30	Top

6.2 Mechanical aspect and pin numbering

- Maximum height from PCB: 45 mm
- Cut pins: 9-12
- Pin distance: 5 mm
- Row distance: 45.5 mm
- External copper shield 15 x 0.05 (mm) connected to pin 11 by tinned wire

Figure 26. Pin side view

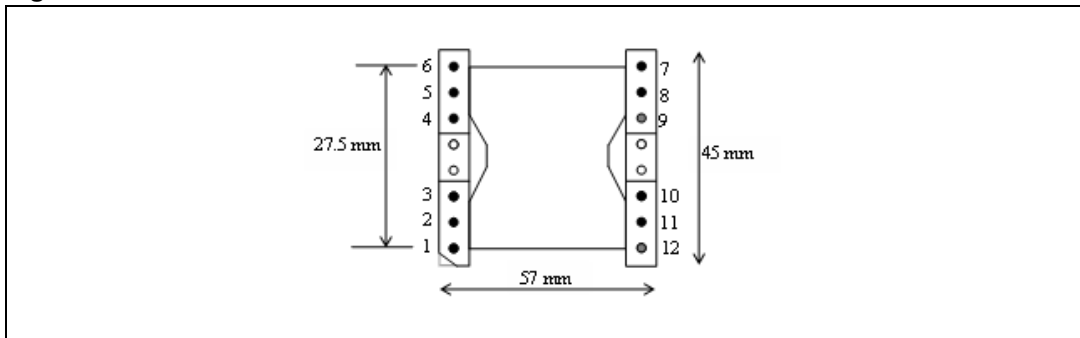

- Manufacturer: DELTA ELECTRONICS
- P/N: 86H-5410

7 Resonant power transformer specification

- Application type: consumer, home appliance
- Transformer type: open
- Coil former: horizontal type, 7+7 pins, 2 slots
- Max. temp. rise: 45 °C
- Max. operating ambient temp.: 60 °C
- Mains insulation: ACC. with EN60065

7.1 Electrical characteristics

- Converter topology: half-bridge, resonant
- Core type: ER49 - PC44 or equivalent
- Min. operating frequency: 75 KHz
- Typical operating freq: 120 KHz
- Primary inductance: 240 $\mu\text{H} \pm 10\%$ @ 1 KHz - 0.25 V [see [Note 1](#)]
- Leakage inductance: 40 $\mu\text{H} \pm 10\%$ @ 1 KHz - 0.25 V [see [Note 1](#)] - [see [Note 2](#)]

- Note: 1 Measured between pins 1-3
 2 Measured between pins 1-3 with the secondary winding shorted

Figure 27. Electrical diagram

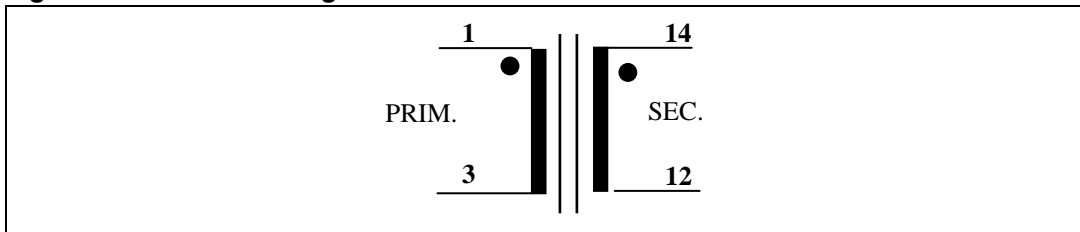
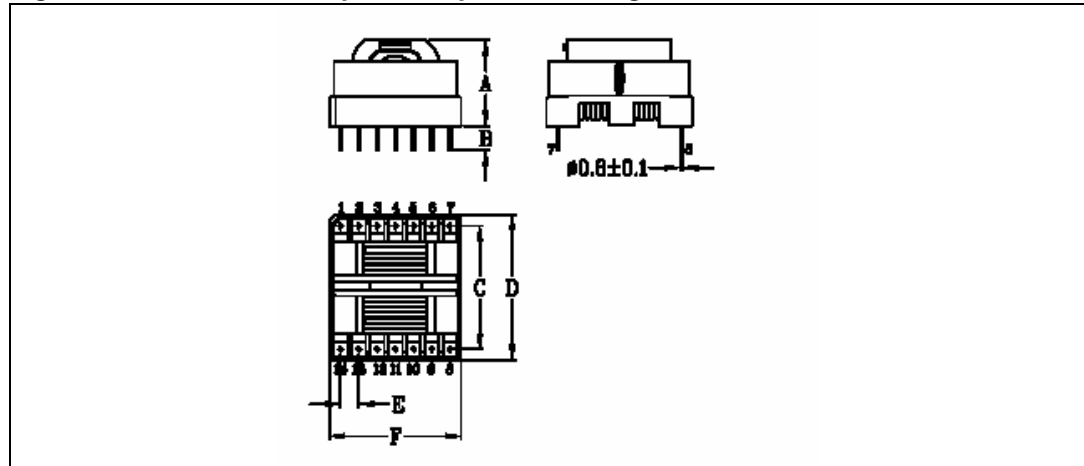

Table 8. Winding characteristics

Pins	Winding	RMS current	N° turns	Wire type
1 - 3	PRIMARY	2.90 A _{RMS}	19	Litz Ø 0.2 mm x 20
14 - 12	SECONDARY	2.25 A _{RMS}	18	Litz Ø 0.2 mm x 20

Figure 28. Mechanical aspect and pin numbering



Note:

Cut PIN 7

- Manufacturer: DELTA ELECTRONICS
- P/N: 86H-6412

Table 9. Mechanical dimensions

	A	B	C	D	E	F
Dimensions (mm)	39.0 max	3.5 ± 0.5	41.6 ± 0.4	51 max	7.0 ± 0.2	51.5 max

Figure 29. Winding position on coil former

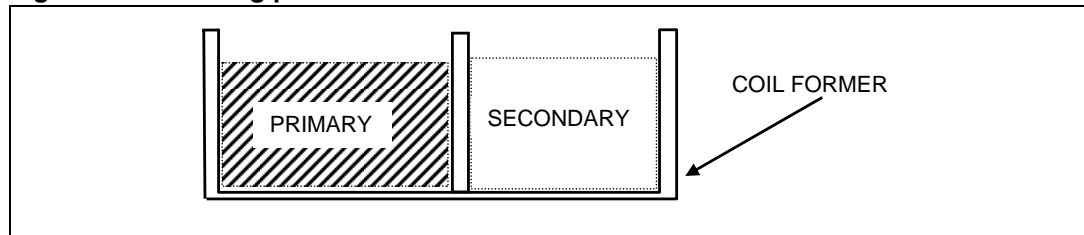

8 Auxiliary flyback power transformer

- Application type: consumer, home appliance
- Transformer type: open
- Winding type: layer
- Coil former: horizontal type, 4+5 pins
- Max. temp. rise: 45 °C
- Max. operating ambient temp.: 60 °C
- Mains insulation: ACC. with EN60065

8.1 Electrical characteristics

- Converter topology: flyback, DCM/CCM mode
- Core type: E20 - N67 or equivalent
- Operating frequency: 60 KHz
- Primary inductance: 4.20 mH $\pm 10\%$ @ 1 KHz - 0.25 V [see [Note 1](#)]
- Leakage inductance: 50 μ H MAX @ 100 KHz - 0.25 V [see [Note 2](#)]

Note: 1 Measured between pins 4-5

2 Measured between pins 4-5 with the secondary windings shorted

Figure 30. Electrical diagram

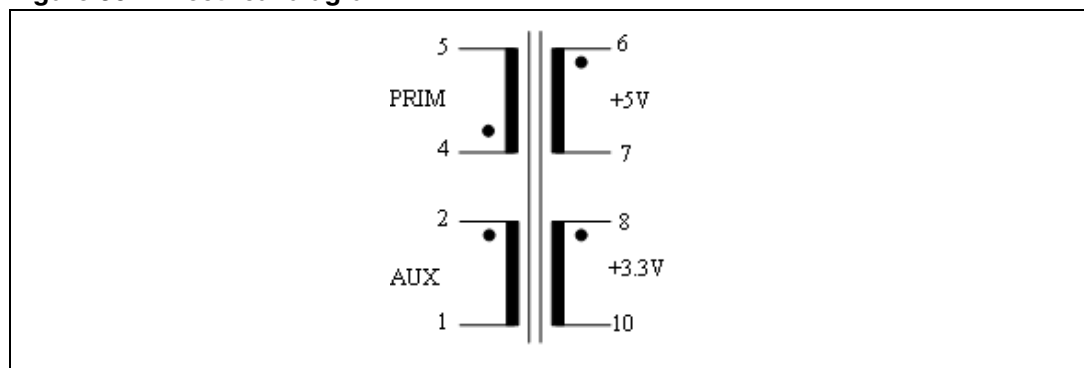

- Manufacturer: DELTA ELECTRONICS
- P/N: 86A - 6079 - R

Table 10. Winding characteristics

Pins: start - end	Winding	RMS current	N° turns	Wire type
4 - 5	PRIMARY	0.2 A _{RMS}	140	G2 - Ø 0.25 mm
2 - 1	AUX	0.05 A _{RMS}	29	G2 - Ø 0.25 mm
8- 10	3.3 V	0.2 A _{RMS}	7	TIW Ø 0.75 mm
6 - 7	5 V	1 A _{RMS}	3	TIW Ø 0.75 mm

Figure 31. Auxiliary transformer winding position on coil former

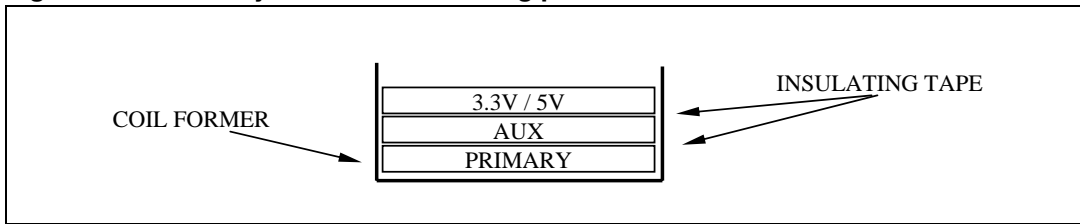

9 Board layout

Figure 32. Copper tracks

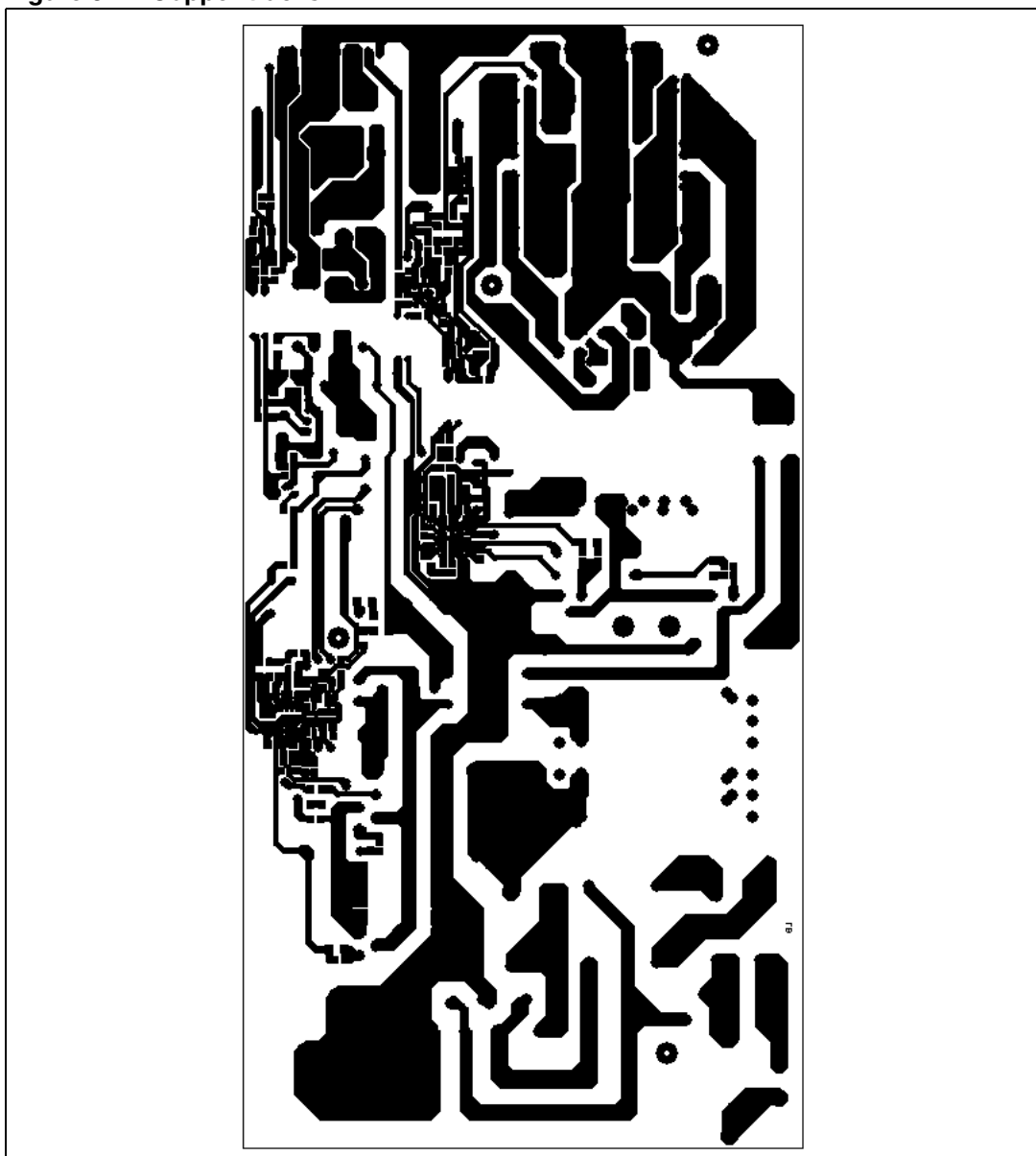

Figure 33. Thru-hole component placing and top silk screen

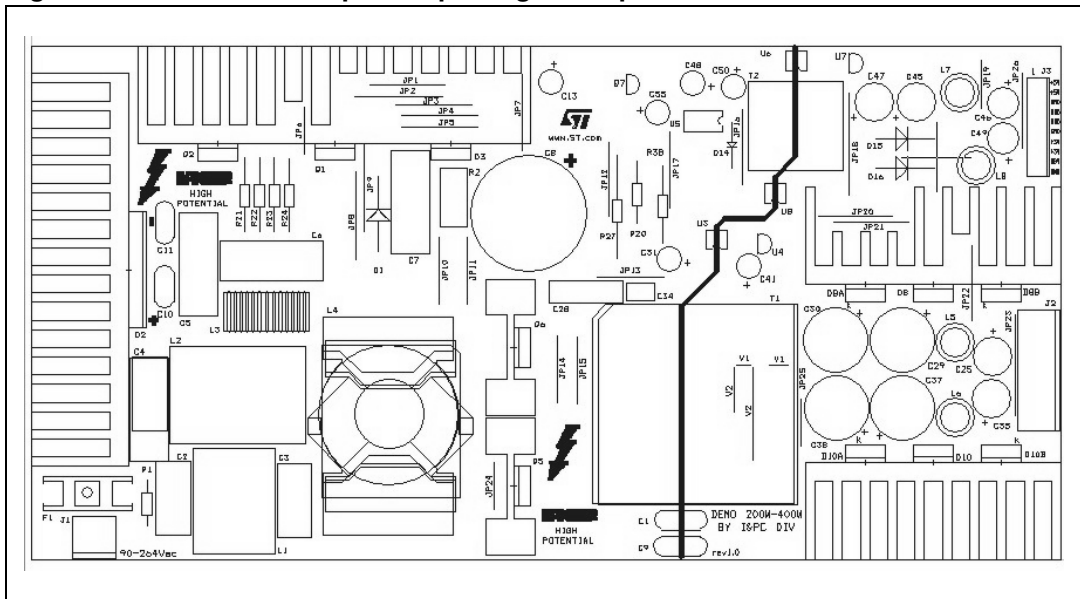
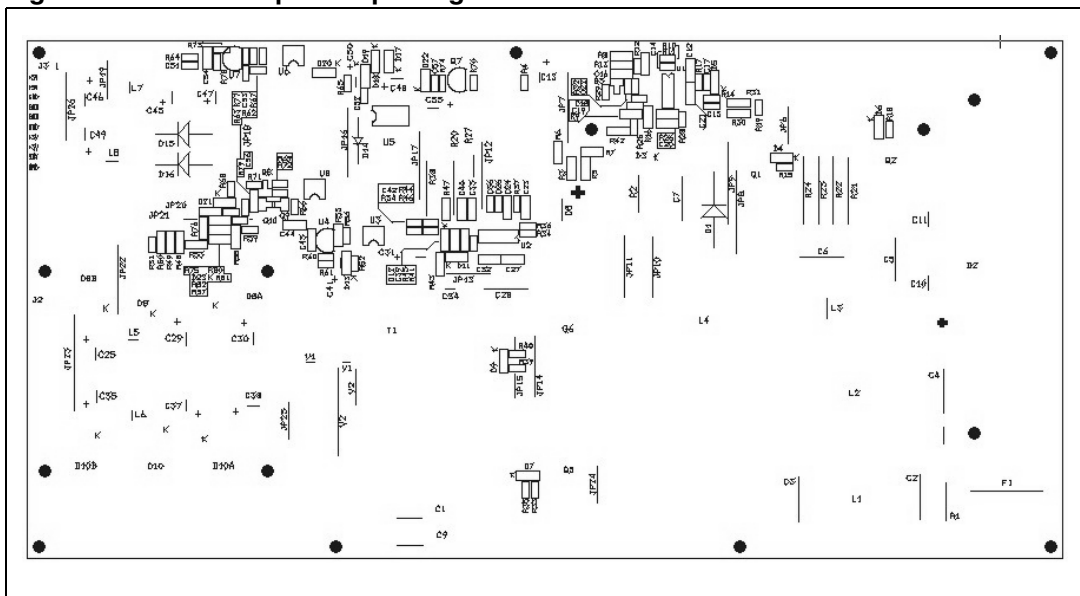

Figure 34. SMT component placing and bottom silk screen



10 References

1. "L6563/L6563A advanced transition-mode PFC controller" Datasheet
2. "Design of Fixed-Off-Time-Controlled PFC Pre-regulators with the L6562", AN1792
3. "L6599 high-voltage resonant controller" Datasheet
4. "LLC resonant half-bridge converter design guideline", AN2450

11 Revision history

Table 11. Revision history

Date	Revision	Changes
28-Feb-2007	1	First issue
23-Apr-2007	2	– Cross references updated – Table 6: Bill of materials modified
12-Jun-2007	3	Figure 2 modified

Please Read Carefully:

Information in this document is provided solely in connection with ST products. STMicroelectronics NV and its subsidiaries ("ST") reserve the right to make changes, corrections, modifications or improvements, to this document, and the products and services described herein at any time, without notice.

All ST products are sold pursuant to ST's terms and conditions of sale.

Purchasers are solely responsible for the choice, selection and use of the ST products and services described herein, and ST assumes no liability whatsoever relating to the choice, selection or use of the ST products and services described herein.

No license, express or implied, by estoppel or otherwise, to any intellectual property rights is granted under this document. If any part of this document refers to any third party products or services it shall not be deemed a license grant by ST for the use of such third party products or services, or any intellectual property contained therein or considered as a warranty covering the use in any manner whatsoever of such third party products or services or any intellectual property contained therein.

UNLESS OTHERWISE SET FORTH IN ST'S TERMS AND CONDITIONS OF SALE ST DISCLAIMS ANY EXPRESS OR IMPLIED WARRANTY WITH RESPECT TO THE USE AND/OR SALE OF ST PRODUCTS INCLUDING WITHOUT LIMITATION IMPLIED WARRANTIES OF MERCHANTABILITY, FITNESS FOR A PARTICULAR PURPOSE (AND THEIR EQUIVALENTS UNDER THE LAWS OF ANY JURISDICTION), OR INFRINGEMENT OF ANY PATENT, COPYRIGHT OR OTHER INTELLECTUAL PROPERTY RIGHT.

UNLESS EXPRESSLY APPROVED IN WRITING BY AN AUTHORIZED ST REPRESENTATIVE, ST PRODUCTS ARE NOT RECOMMENDED, AUTHORIZED OR WARRANTED FOR USE IN MILITARY, AIR CRAFT, SPACE, LIFE SAVING, OR LIFE SUSTAINING APPLICATIONS, NOR IN PRODUCTS OR SYSTEMS WHERE FAILURE OR MALFUNCTION MAY RESULT IN PERSONAL INJURY, DEATH, OR SEVERE PROPERTY OR ENVIRONMENTAL DAMAGE. ST PRODUCTS WHICH ARE NOT SPECIFIED AS "AUTOMOTIVE GRADE" MAY ONLY BE USED IN AUTOMOTIVE APPLICATIONS AT USER'S OWN RISK.

Resale of ST products with provisions different from the statements and/or technical features set forth in this document shall immediately void any warranty granted by ST for the ST product or service described herein and shall not create or extend in any manner whatsoever, any liability of ST.

ST and the ST logo are trademarks or registered trademarks of ST in various countries.

Information in this document supersedes and replaces all information previously supplied.

The ST logo is a registered trademark of STMicroelectronics. All other names are the property of their respective owners.

© 2007 STMicroelectronics - All rights reserved

STMicroelectronics group of companies

Australia - Belgium - Brazil - Canada - China - Czech Republic - Finland - France - Germany - Hong Kong - India - Israel - Italy - Japan - Malaysia - Malta - Morocco - Singapore - Spain - Sweden - Switzerland - United Kingdom - United States of America

www.st.com

